



SWIM SERIES OWNERS MANUAL

bullfrog[®]
spas

QUICK REFERENCE

To assist you with the installation and maintenance service of your new spa, please fill out the following information and keep it on hand for future reference.

My Spa Information

Model: _____

Serial Number: _____

Dealership: _____

Dealer's Phone Number: _____

Date Purchased: _____

Date Installed: _____

Contractor Information

General

1. Name: _____

Telephone: _____

2. Name: _____

Telephone: _____

Electrician

1. Name: _____

Telephone: _____

2. Name: _____

Telephone: _____

Concrete, Decking, and Masonry

1. Name: _____

Telephone: _____

2. Name: _____

Telephone: _____

Landscaping

1. Name: _____

Telephone: _____

2. Name: _____

Telephone: _____

TABLE OF CONTENTS

Quick Reference:	1
Table of Contents:	2
Important Overview:	3
Safety Instructions & Warnings:	4
Getting to Know Your Spa:	8
Filling Your Spa:	10
Start-up, Controls & Functions:	11
JetPaks & Jets:	18
Water Care:	20
Spa Maintenance:	25
Fitness & Relaxation Accessories:	29
Site Preparation, Installation, & Delivery:	34
Hardware Setup & Wiring Diagrams:	39
Electrical Chaseway & Stub-up Diagrams:	40
GFCI Wiring Diagrams:	41
Display and Error Messages:	42
Troubleshooting Guide:	43
Limited Warranty:	44

IMPORTANT OVERVIEW



Congratulations on the purchase of your new Swim Series spa.

NOTE: Take a moment to read this manual carefully. Following the instructions in this manual will ensure the safe and smooth operation of your new spa. In this document, the terms “Spa” and “Pool” may be used interchangeably.

Carefully read this Owner’s Manual before you install your Swim Series spa. Your Swim Series Limited Warranty may be voided if damage is caused by failure to install, maintain, and operate your spa in accordance with the recommendations contained in this Owner’s Manual or any other printed instruction, notice or bulletin from Bullfrog Spas. Your spa’s serial number is located both on the base under the equipment door and the Manufacturing ID Label located inside the equipment compartment.

For the safety of all those who utilize your spa and its surroundings, please make sure your spa and any adjoining installations, including the electrical hook-up, are completed according to codes of and only after acquiring any necessary approvals and permits from your local, state/provincial, and/or national government. Follow all local, state, and national safety and wiring rules. Some jurisdictions require certain fencing and/or self-closing and self-latching gates to prevent accidental drowning in a pool or spa. Your spa cover comes with a locking system that meets the ASTM F1346-91 Standard for Safety Covers, which when properly used, may satisfy certain fencing and gating requirements. Your spa meets or exceeds all requirements of the Virginia Graeme Baker Pool and Spa Safety Act. Your spa has been tested and either meets or exceeds the UL-1563 portable spa standard.

U.S. Patents: 7,908,684, 8,661,576, 8,881,321, 8,689,370, 8,869,469, 5,754,989, 5,987,663, 6,000,073, 6,092,246, 6,256,805, 6,543,067.

New Zealand Patent: 555112, 334,093

Australia Patent: 737,335

Canada Patents: 2,588,884, 2,260,237, 2,915,184

Other patents pending worldwide

Bullfrog Spas reserves the right to change features, specifications & design without notification and without incurring any obligation.

Swim Series units are available in the following models:

S150, S180, S180XD, S200



SAFETY INSTRUCTIONS & WARNINGS

Safety Instructions

When installing and using this electrical equipment, basic safety precautions should always be followed, including the following:

Read, & follow all instructions:

1. **▲ WARNING:** To reduce the risk of injury, do not permit children to use this product unless closely supervised at all times.
2. As per UL requirements (U.S.), a wire connector is provided on this unit to connect a minimum No. 8 AWG (8.4mm²) solid copper conductor between this unit and any metal equipment, metal enclosures of electrical equipment, metal water pipe, or conduit within 5 feet (1.5m) of the unit.
3. **▲ DANGER:** Risk of Accidental Drowning. Extreme caution must be exercised to prevent unauthorized access by children. To avoid accidents, ensure that children cannot use this spa unless they are supervised at all times.
4. **▲ DANGER:** Risk of Injury. The suction fittings in the spa are sized to match the specific water flow created by the pump. Should the need arise to replace the suction fittings or the pump, be sure that the flow rates are compatible. Never operate the spa if the suction fittings are broken or missing. Do not replace a suction fitting with one rated less than the flow rate marked on the original suction fitting.
5. **▲ DANGER:** Risk of Hair Entrapment. The spa includes parts that rotate and/or oscillate. Extreme caution must be exercised by those with long hair to avoid contact with moving parts and potential entrapment. It is highly recommended that hair is controlled and/or kept out of the water in such a way as to avoid moving spa parts.
6. **▲ DANGER:** Risk of Electric Shock. As per UL requirements (U.S.), install spa at least 5 feet (1.5m) from all metal surfaces. A spa may be installed within 5 feet (1.5m) of metal surfaces if each metal surface is permanently connected by a minimum of No. 8 AWG (8.4mm²) solid copper conductor to the wire connector on the terminal box that is provided for this purpose.
7. **▲ DANGER:** Risk of Electric Shock. Do not permit any electrical appliances, such as a light, telephone, radio, or television within 5 feet (1.5m) of the spa. These units DO NOT have an integral ground fault circuit interrupter. The installation of an integral ground fault circuit interrupter MUST be completed by a qualified Electrician and must meet all local and national electrical codes.
8. **▲ WARNING:** To Reduce the Risk of Injury:
 - a. Water temperature in a spa should never exceed 104°F (40 ° C). Water temperatures between 100° F (38°C) and 104°F (40°C) are considered safe for a healthy adult. Water temperature in excess of 104° F (40° C) may be harmful to your health. Lower temperatures are recommended for young children and/or when spa use exceeds 10 minutes.
 - b. High temperatures could have a potential for causing fetal damage during pregnancy. Pregnant women or women that could be pregnant should consult a physician and possibly limit spa usage when temperatures are in excess of 100° F (38° C).
 - c. Before entering the spa, measure the water temperature with an accurate thermometer since tolerances of water temperature regulating devices may vary.
 - d. Use of alcohol, drugs, or medication before or during spa use may lead to unconsciousness with the possibility of drowning.
 - e. Persons suffering from obesity or a medical history of heart disease, low or high blood pressure, circulatory system problems, and/or diabetes should consult a physician before using a spa.
 - f. Persons using medication should consult a physician before using a spa. Some medications may induce drowsiness while other medication may affect heart rate, blood pressure, and/or circulation.
9. **▲ WARNING:** PEOPLE WITH INFECTIOUS DISEASES SHOULD NOT USE A SPA OR POOL.
10. **▲ WARNING:** TO AVOID INJURY, EXERCISE CARE WHEN ENTERING OR EXITING THE SPA OR POOL. NEVER DIVE OR JUMP INTO THE SPA.
11. **▲ WARNING:** DO NOT USE A SPA OR POOL IMMEDIATELY FOLLOWING STRENUOUS EXERCISE.
12. **▲ WARNING:** PROLONGED IMMERSION IN A SPA OR POOL MAY BE HARMFUL TO YOUR HEALTH.
13. **▲ CAUTION:** MAINTAIN WATER CHEMISTRY IN ACCORDANCE WITH MANUFACTURER'S INSTRUCTION.
14. **▲ CAUTION:** ADEQUATE DRAINAGE MUST BE PROVIDED IF THE EQUIPMENT IS TO BE INSTALLED BELOW GROUND LEVEL.
15. **▲ WARNING:** Risk of Fatal Hyperthermia. Hyperthermia occurs when the internal temperature of the body reaches a level several degrees above the normal body temperature of 98.6° F (37° C). The symptoms of Hyperthermia include dizziness, lethargy, drowsiness, and fainting. The use of alcohol, drugs, and/or medication can greatly increase the risk of fatal Hyperthermia.

The effects of Hyperthermia include:

 - a. Unawareness of impending hazard
 - b. Failure to perceive heat
 - c. Failure to recognize the need to exit the spa
 - d. Physical inability to exit the spa
 - e. Fetal damage in pregnant women
 - f. Unconsciousness and danger of drowning
16. **▲ WARNING:** Risk of Children Drowning. Your spa

cover is not rated as a safety cover. It is suggested to always keep the spa cover securely fastened when not in use. This will discourage children from attempting to enter the spa unsupervised. If cover is damaged it should be replaced.

17. **▲ WARNING:** Risk of Drowning. Use caution when bathing alone. Overexposure may cause nausea, dizziness, and fainting.
18. **▲ CAUTION:** Risk of Injury. Young children should always be supervised so that they do not play in or around the spa.
19. **▲ WARNING:** Keep all glassware and other breakable objects away from the spa area.
20. **▲ WARNING:** Risk of Injury: Short-term inhalation of high concentrations of ozone and long-term inhalation of low concentrations of ozone can cause serious physiological effects.
21. **▲ CAUTION:** Unauthorized Access. Secure the spa area against unauthorized access. Make sure all spa barriers (fences, enclosures, etc.) meet all applicable national and local codes. Keep spa cover on and locked when it is not being used.
22. **▲ CAUTION:** Risk of Damage to Spa or Equipment. By performing maintenance as described in this manual, the chance of damage to your spa and its equipment will be reduced. Never block the air vents that lead to the spa's equipment compartment, doing so may cause the spa to overheat.
23. **▲ WARNING:** Risk of Electric Shock or Death. Do not operate spa during severe weather conditions (e.g. electrical storms, tornadoes, etc.).
24. **▲ CAUTION:** Non-Approved Accessories. Using accessories not approved by Bullfrog International, LC could void your warranty or cause other problems. Please consult your authorized Bullfrog Spas Dealer.
25. **▲ CAUTION:** Spa Location. Locate your spa on a foundation that can support the maximum filled weight of your spa along with the weight of all the occupants using the spa (see Site Selection and Preparation). Also, locate your spa in an environment that can withstand repeated exposure to water and the possibility of a major spill.
26. **▲ CAUTION:** Power cords must be replaced only with a special cord assembly available from the Manufacturer, its Service Agent, or similarly qualified persons in order to avoid a hazard.
27. **▲ WARNING:** This appliance is not intended for use by young children or unhealthy persons without supervision.
28. **▲ WARNING:** Before obtaining access to supply terminals, all supply circuits must be disconnected.
29. **▲ WARNING:** Risk of Injury or Accidental Drowning: Do not use spa without filters, filter housing, and weir covers

installed; these parts serve as a barrier against bodily entrapment against the filter suction fitting(s).

30. **▲ CAUTION:** Test the GFCI or RCD (Residual Current Device) before each use of the spa.
31. **▲ WARNING:** Spas equipped with JetPaks are intended to operate with all JetPaks. Do not operate spa without all JetPaks, JetPak caps, and headrests securely in place.
32. **▲ WARNING:** Risk to Infants, Elderly, and Women Planning or Experiencing Pregnancy. Please consult your physician if the above applies to you or anyone using the spa

Additional Instructions

(Canadian Installations Only):

33. A green-colored terminal or a terminal marked G, GR, Ground, Grounding or the international grounding symbol is located inside the supply terminal box or compartment. To reduce the risk of electric shock, this terminal must be connected to the grounding means provided in the electric supply service panel with a continuous copper wire equivalent in size to the circuit conductors supplying this equipment.
34. At least two lugs marked "BONDING LUGS" are provided on the external surface or on the inside of the supply terminal box or compartment. To reduce the risk of electric shock, connect the local common bonding grid in the area of the spa or hot tub to these terminals with an insulated or bare copper conductor not smaller than No. 6 AWG.
35. All field-installed metal components such as rails, ladders, drains, or other similar hardware located within 10 feet (3m) of the spa or hot tub must be bonded to the equipment grounding bus with copper conductors not smaller than No. 6 AWG.

Warning Signs (North America)

Included with the spa are required warning signs to inform spa users of the risks involved with a spa, including a warning against diving and reminder to watch children at all times.* These signs are suitable for indoor and outdoor use in a protected location. They should be placed in a noticeable and visible location adjacent to the spa. For free additional copies, contact your Authorized Swim Series Dealership.

*Final warning sticker is included with spa for installation by owner.



REDUCE THE RISK OF ELECTROCUTION

1. NEVER PLACE AN ELECTRIC APPLIANCE WITHIN 5 FEET OF SPA

REDUCE THE RISK OF CHILD DROWNING

1. SUPERVISE CHILDREN AT ALL TIMES.
2. ATTACH SPA COVER AFTER EACH USE.

REDUCE THE RISK OF OVERHEATING

1. CHECK WITH A DOCTOR BEFORE EACH USE IF PREGNANT, DIABETIC, IN POOR HEALTH, OR UNDER MEDICAL CARE.
2. EXIT IMMEDIATELY IF UNCOMFORTABLE, DIZZY, OR SLEEPY. SPA HEAT CAN CAUSE HYPERTHERMIA AND UNCONSCIOUSNESS
3. SPA HEAT IN CONJUNCTION WITH ALCOHOL, DRUGS, OR MEDICATION CAN CAUSE UNCONSCIOUSNESS.

WHEN PREGNANT, SOAKING IN HOT WATER FOR LONG PERIODS CAN HARM YOUR FETUS.

MEASURE WATER TEMPERATURE BEFORE ENTERING.

1. DO NOT ENTER SPA IF WATER IS HOTTER THAN 100°F (38°C)
2. DO NOT STAY IN SPA FOR LONGER THAN 10 MINUTES.

THIS MARKING IS TO BE REMOVED ONLY BY THE OWNER AFTER SAFETY SIGN IS INSTALLED

69.1-S



REDUCE THE RISK OF ELECTROCUTION

1. NEVER PLACE AN ELECTRIC APPLIANCE WITHIN 5 FEET OF SPA

REDUCE THE RISK OF CHILD DROWNING

1. SUPERVISE CHILDREN AT ALL TIMES.
2. ATTACH SPA COVER AFTER EACH USE.

REDUCE THE RISK OF OVERHEATING

1. CHECK WITH A DOCTOR BEFORE EACH USE IF PREGNANT, DIABETIC, IN POOR HEALTH, OR UNDER MEDICAL CARE.
2. EXIT IMMEDIATELY IF UNCOMFORTABLE, DIZZY, OR SLEEPY. SPA HEAT CAN CAUSE HYPERTHERMIA AND UNCONSCIOUSNESS
3. SPA HEAT IN CONJUNCTION WITH ALCOHOL, DRUGS, OR MEDICATION CAN CAUSE UNCONSCIOUSNESS.

WHEN PREGNANT, SOAKING IN HOT WATER FOR LONG PERIODS CAN HARM YOUR FETUS.

MEASURE WATER TEMPERATURE BEFORE ENTERING.

1. DO NOT ENTER SPA IF WATER IS HOTTER THAN 100°F (38°C)
2. DO NOT STAY IN SPA FOR LONGER THAN 10 MINUTES.

70.1-0

WARNING

REDUCE THE RISK OF ELECTROCUTION

1. NEVER PLACE AN ELECTRIC APPLIANCE WITHIN 5 FEET OF SPA
2. DO NOT INSTALL UNDER SPA SKIRT OR WITHIN AN ENCLOSURE THAT WOULD RESTRICT VENTILATION.
3. IF BLOWER IS INCLUDED, INSTALL AT LEAST 1 FOOT ABOVE MAXIMUM WATER LEVEL.

REDUCE THE RISK OF CHILD DROWNING

1. SUPERVISE CHILDREN AT ALL TIMES.
2. ATTACH SPA COVER AFTER EACH USE.
3. INSTALL A SUCTION GUARD WITH MARKED FLOW RATE NO LESS THAN ____ GPM TO AVOID HAIR & BODY ENTRAPMENT.

REDUCE THE RISK OF OVERHEATING

1. CHECK WITH A DOCTOR BEFORE EACH USE IF PREGNANT, DIABETIC, IN POOR HEALTH, OR UNDER MEDICAL CARE.
2. EXIT IMMEDIATELY IF UNCOMFORTABLE, DIZZY, OR SLEEPY. SPA HEAT CAN CAUSE HYPERTHERMIA AND UNCONSCIOUSNESS
3. SPA HEAT IN CONJUNCTION WITH ALCOHOL, DRUGS, OR MEDICATION CAN CAUSE UNCONSCIOUSNESS.

WHEN PREGNANT, SOAKING IN HOT WATER FOR LONG PERIODS CAN HARM YOUR FETUS.

MEASURE WATER TEMPERATURE BEFORE ENTERING.

1. DO NOT ENTER SPA IF WATER IS HOTTER THAN 100°F (38°C)

2. DO NOT STAY IN SPA FOR LONGER THAN 10 MINUTES. 70.2-E

 **WARNING**

<h3>NO DIVING!</h3> <p>Shallow water. You can be permanently injured.</p> 	<h3>PREVENT DROWNING</h3> <p>Watch children at all times.</p> 
--	--

60-03038

GETTING TO KNOW YOUR SPA

Spa Overview Swim Series

[S150 pictured with optional Premium Aquatic Surface Package]

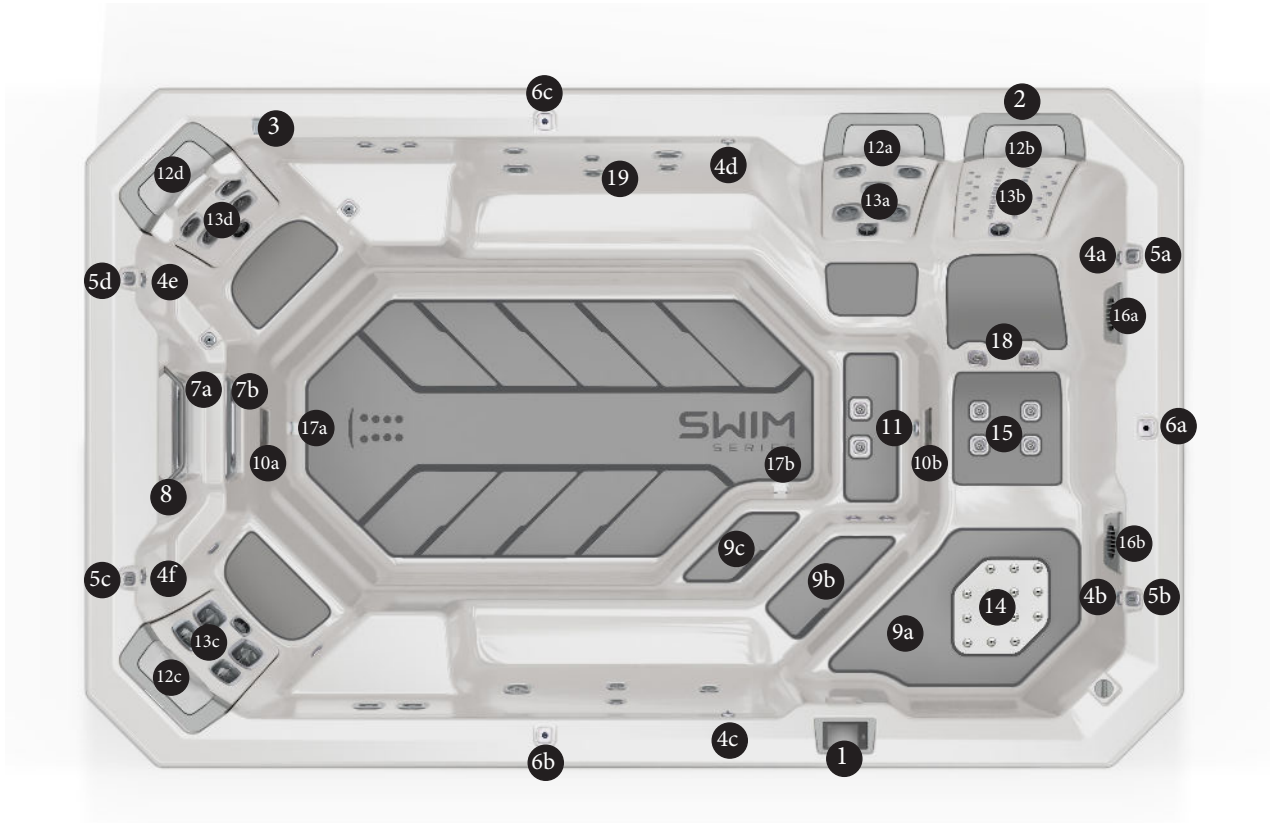

1. Main touch-screen control
2. Simplicity spa filter (located behind JetPak)
3. Multi-function auxiliary control
4. Accessory anchors (4a, 4b, 4c, 4d, 4e, & 4f)
5. Brandmark water features (5a, 5b, 5c, & 5d)
6. Vertical accessory mounts (6a, 6b, & 6c)
7. Swim current jets (7a & 7b)
8. Swim & exercise hand rail
9. Easy-entry steps (9a, 9b, & 9c)
10. Main LED lights (10a & 10b)
11. Ozone jet
12. Snap cap/headrest assembly & JetPak access (12a, 12b, 12c, & 12d)
13. JetPaks (13a, 13b, 13c, & 13d)
14. Splash pad kids play area
15. Exercise seat
16. Filter intakes & weirs (16a & 16b)
17. Floor drains (17a & 17b)
18. Foot, leg, & arm therapy jets (multiple)
19. Spa wall therapy jets (multiple)

Spa Equipment Compartment Swim Series

[S150 pictured, shown with equipment access panel removed]



1. Jet pump 1
2. Jet pump 2
3. Filtration pump
4. Control box
5. Water heater
6. Electronic valve control system
7. Clear Comfort AOP system
8. Safety certification label
9. Serial number sticker
10. Support studs
11. Cabinet attachment notches in support stud
12. ABS spa base pan
13. Audio control box
14. Audio subwoofers
15. Cloud Control module
16. Acrylic spa shell
17. Main plumbing lines
18. External air bleeder
19. Drain cap & assembly

FILLING YOUR SPA

WARNING: An empty spa (spa without water in it) must not be left exposed to sunlight as shell damage may occur. Once the spa is unwrapped, fill spa with water immediately or shade the spa with cover to prevent direct exposure to sunlight.

IMPORTANT: Do not turn power on to the spa without water in the spa. Serious damage to the pumps and/or heater may occur.

WARNING: Make sure power is off to your spa prior to following spa filling procedure. Failure to do so may result in serious injury.

NOTE: To avoid a possible airlock condition be sure to open all valves in the JetPaks and all other jets in the spa before filling. This will allow as much air as possible to escape from the system during the filling process.

Spa Filling

IMPORTANT: Never fill the spa with soft water unless an appropriate mineral supplement is immediately added (see your authorized Bullfrog Spas Dealer). If your water is extremely hard, it is preferable to either dilute the water's hardness by blending the water with water from a water softener, using a mineral filter, or by the addition of a special water softening chemical (see your authorized Bullfrog Spas Dealer).

Step 1: Select any seat with a JetPak. Push the JetPak forward to expose the opening behind the JetPak.



Step 2: Place garden hose in the opening behind the JetPak.



Step 3: Fill to the water level indicator or the mid point of the filter intake grate and proceed to start up procedure.

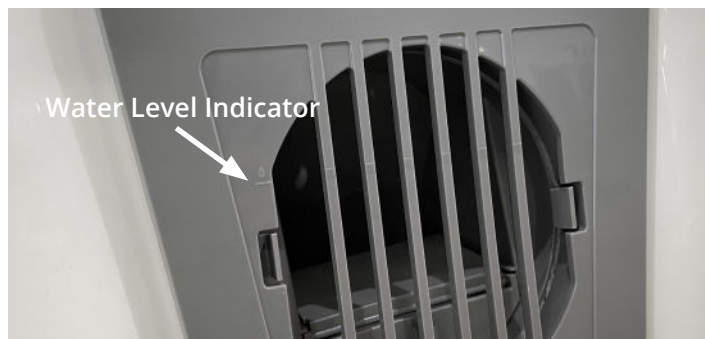

Step 4: Check for leaks: After the spa is filled, check all fittings and equipment in equipment compartment for signs of leakage before turning on the spa. Turn on pump(s), once again, check for leakage. If a leak is detected, tighten the fitting by hand. If the leak persists contact your authorized Bullfrog Spas Dealer.

Step 5: Install Cover: The spa cover comes with tie down straps and locking hardware that attaches the cover to the spa or decking. If your Dealer did not install the cover, refer to the Cover Installation Instructions included with the cover.

Cover locks are an essential component for compliance with the ASTM F1346-91 safety standard for spa covers.

START-UP, CONTROLS, & FUNCTIONS



Swim Series Touch Control



Swim Series Standard Auxiliary Control

IMPORTANT: Your Swim Series spa is equipped with one main control and one auxiliary control that correspond to the spa model. Locate your controls by matching with the photo here and follow the specific instructions in the section dedicated to the operation of your spa model and type of controls.

Start Up

NOTE: Ensure the spa is filled to its correct operating level. For details see “Filling your spa” section. To avoid a possible airlock condition be sure to open all valves in the JetPaks and all other jets in the spa before filling. This will allow as much air as possible to escape from the system during the filling process.



Power Up

Begin the start up process by turning the power on at the main power panel. This is most often done by moving a breaker switch to the On position. Once the spa is powered, the control panel display will go through an initializing sequence. This sequence displays information regarding the spa configuration. After a few seconds, your control will display a standard status screen with time, temperature status, jet and light status, operation mode, etc.





Once initialized, the spa control will go to sleep after 30 seconds without activity. To proceed with start up, tap screen with your

finger tip to wake up the control. Touch and drag the logo icon  to the reverse logo icon  to unlock and access controls.

Prime the Pumps

Pumps must be primed directly after filling to ensure correct operation of your spa. After initial start up, verify that the home status screen appears on the panel. Ensure that your Swim Series spa is in Spa mode. Prime each of the pumps. Begin by pressing the  “Jets 1” button once to prime Pump 1 in low-speed. After Pump 1 turns on and water is visibly flowing from the jets wait a few seconds and then press  “Jets 1” again to initiate high-speed operation of Pump 1. The pump has primed when water is flowing from the jets.

Repeat the priming process for each additional pump on your Swim Series model. All pumps will have primed when water is observed flowing from the jets associated with each pump.

After priming all jet pumps in Spa mode, switch to Swim mode by locating the Spa Mode icon  in the center of the main control, touch the Swim Mode icon . Wait 20 seconds for Swim Mode to initiate. Turn on the swim jets by pressing the Start icon . Increase current intensity with the right arrow icon . Ensure water is flowing from both the top and bottom swim jets and turn off by pressing the Stop icon .

IMPORTANT: If pumps fail to prime you may have a condition know as "air lock." Pumps should not be allowed to run in this condition (without priming and no water flowing out of the jets) for more than 2 minutes. Doing so may cause damage to the pump(s).

NOTE: Closing and opening all adjustable jets and JetPak valves may help release air from the system. In addition, momentarily turning the pump off and on may also help release air from the system, allowing pumps to prime. Do not attempt to turn pumps off and on more than 5 times. If the pump(s) will not prime, shut off the power to the spa and call for service.

External Air Bleeder Instructions

These instructions should be followed at initial and subsequent draining and refilling to prevent pump cavitation caused by trapped air within the pump and plumbing system.

Turning on the power to the spa before performing this priming process may make the priming process more difficult.

Priming instructions:

Step 1: Remove the filter cover and filter from the spa. Fill the spa to the proper level using the instructions listed in “Filling Your Spa” above.

Step 2: Fill the spa to the proper water level described in your spa owner’s manual.

Note: A water level indicator is located in the center of the weir or skimmer cover.

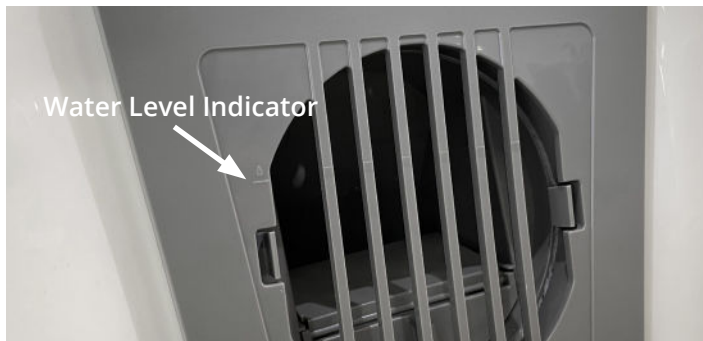

Step 3: Using caution, carefully remove the air bleeder screw from the external air bleeder fitting with a standard flathead screwdriver or ½” socket to unscrew it in a counterclockwise rotation.

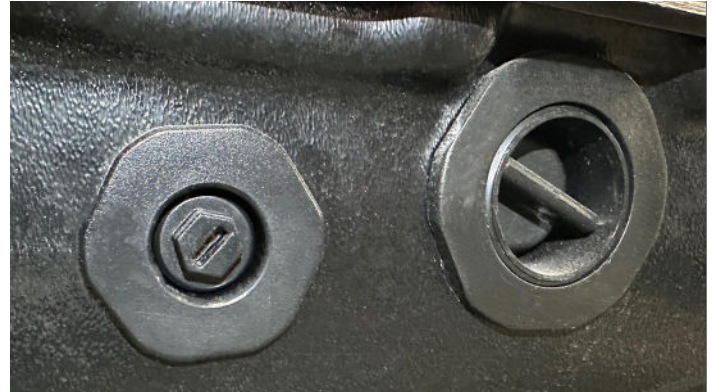

Air Bleeder Screw & Screw (left of drain outlet assembly)

Note: To prevent losing the bleeder screw and O-ring, grasp the screw while unthreading. Once removed, air and water will begin to escape through the opening.

Step 4: Allow water to flow freely from the external air bleeder fitting for approximately 60 seconds, or until water is a steady stream with no air.

Note: Use a wet/dry vacuum or tray to catch escaping water for spa installations located indoors.

Step 5: After 60 seconds, or a steady stream of water is observed, reinstall the bleeder screw and O-ring. First, by hand and then by using a standard screwdriver until snug. Do not over-tighten.

Step 6: Turn on the power to the spa and turn on one pump at a time starting with pump 1, ensuring that each pump is properly primed. If you discover a pump is not moving water properly after 30-60 seconds, turn off the power to the spa and repeat steps 3 through 6.

Note: Spa equipment with circulation pumps are not as noticeable when operating correctly; for this reason, you will need to watch the control panel closely for approximately 60 seconds or until the display reads “Heating to 99°F (37°C)” (or Heating to 104°F / 40°C). If the panel displays **ERROR NO FLO**, turn off the power to the spa and repeat steps 3 through 6.



Spa Mode Display





Swim Mode Display

Home/Status Screen

The Home/Status screen on your Swim Series main control shows basic statuses including: time, jet status, light status, screen orientation, current water temperature, heating/cooling status, spa operation mode, audio status (optional), day/night status, and settings. Most basic functions of operating your spa can be performed with one touch from the Home/Status screen. In addition, any necessary error or maintenance messages will appear at the bottom of the screen.

Switch Between Spa & Swim Modes



To switch from Spa Mode to Swim mode touch the Swim Mode icon . The electronic valve will actuate.* Swim Mode functions will become operational. To switch to Spa Mode touch the Spa Mode icon . icon and the electronic valve will actuate* and Spa Mode functions will become operable.

***NOTE:** During valve actuation a notification will appear and neither Spa Mode nor Swim Mode functions will be operable for approximately 20 seconds as you switch between modes.

Start or Stop Accessories

To start or stop an accessory (jets, lights, etc.), press the associated icon button. Icons will become animated when their accessory is turned on, and inanimate when turned off. Icons on the screen will reflect the speed or state of the devices running on your spa. When an accessory has more than two states, such as the swim current jets, press the button once, and then again, until it reaches the desired state.



Light Operation

Press the  (lights) icon to access the lights menu. Use the  (interior) icon to turn on interior lights. Use the  (exterior lights) icon to turn on exterior lights. Use the associated menu options to control interior light modes (flashing, fading, solid color) and/or colors.

Invert Screen

From the home status screen you may press the  (invert screen) icon to rotate the screen 180 degrees for easier viewing from inside the spa.

Adjusting the Set Temperature

Within 1 to 2 minutes after spa start up and initialization, the water temperature will be displayed in the center of the home status screen. Press the  and  buttons to set the desired temperature.

When the set value is lower than the current temperature “Cooling to xx.x” will appear at the bottom of the screen. When the set value is higher than the current temperature, “Heating to xx.x” will be indicated. Normally there may be a short delay before the heating starts, during which “Heating suspended” is indicated under the value.

Swim Functions

Your Swim Series spa is equipped with several features and functions allowing you to pursue your fitness goals. Use the following section to understand swim drills, fitness modes, and how to customize and tailor your experience to fit your preferences.

Press the  (swim setting) icon to access the swim settings menu. Here you can adjust swim drill settings, select pre-programmed drills, or personalize your own swim drills.

Warm Up

Use the up or down arrows on the left of the Warm Up screen to configure the duration of your warm up period between 0 and 5 minutes. Use the up or down arrows at the right of the Warm Up screen to adjust the intensity of your warm up between speeds 1 and 5.

NOTE: Pressing the blue arrows at the bottom of the Warm Up screen will allow you to cycle and select between Warm Up, Cool Down, Preparation Time, Step Time, and Light Feedback, in this order.

Cool Down

Use the up or down arrows on the left of the Cool Down screen to adjust the duration of your cool down period between 0 and 5 minutes. Use the up or down arrows at the right of the Cool Down screen to adjust the intensity of your cool down. Selections range from speeds 1 through 5.

Preparation Time

Use the up or down arrows on the left of the Preparation Time screen to configure the duration of your preparation period between 0 and 60 seconds. This is the amount of time you will need to move from the controls to the swim lane to begin your workout. Preparation Time will display as a countdown timer once you press the  (go) icon to begin your swim drill.

Step Time

Step Time is the time between speed changes within your selected swim drill. Use the up or down arrows on the Step Time screen to configure the duration of each step in your drill between 90 and 180 seconds.

Light Feedback



Use the Light Feedback function to use specific lights to give you warnings and feedback during your swim workouts.

Press the  (light 1) icon to enable interior light feedback. All interior lights will flash to alert the swimmer of speed changes.

Press the  (light 3) icon to enable exterior light feedback. All exterior lights will flash to alert spectators outside of the spa (coaches, parents, etc.) of speed changes.

NOTE: Pressing the  (light 2) icon will not make any changes. This function is currently inactive in Swim Series spas.

Pre-Programmed Drills



Press the  (swim setting) icon to access the swim settings menu. Press the  (swim drills) icon to view the pre-programmed drill menu. You will be able to select from five pre-programmed swim drills: Endurance, Lap, Transition, Cardio, or Power. Press the name of your desired drill to begin.

Endurance

This swim drill will operate at the selected Intensity and Duration without “Step” or speed changes.

Select the desired length of your Endurance drill by pressing the up or down arrows under Duration. Scroll between 10 and 60 minutes.

Select the desired intensity by pressing the up or down arrows under Intensity. Swim current speeds range from 1 through 5.

Press the  (go) icon to start the Preparation countdown. Your countdown time setting may be adjusted according to your preference in the Preparation Time menu. Pressing the  (pause/standby) icon will temporarily suspend timer operation, while pressing the  (stop) icon will stop the drill and revert to the previous setup screen.

Lap

This swim drill will perform both high and low-intensity intervals of equal step time.

Select the desired length of your Lap drill by pressing the up or down arrows under Duration. Scroll between 10 and 60 minutes.

Next, select the desired intensity by pressing the up or down arrows under Intensity. Swim current speeds range from 1 through 5.

Transition

This swim drill will perform a series of equal length steps at random intensities.

Select the desired total length of your transition drill by pressing the up or down arrows under Duration. Scroll between 10 and 60 minutes.

Next, select the desired intensity by pressing the up or down arrows under Intensity. Swim current speeds range from 1 through 5.

Cardio

This swim drill will perform two successive steps at high intensity for one step at low intensity.

Select the desired length of your Cardio drill by pressing the up or down arrows under Duration. Scroll between 10 and 60 minutes.

Next, select the intensity by pressing the up or down arrows under Intensity. Swim current speeds range from 1 through 5.

Power



This swim drill will perform a pyramid-shaped program, where intensity will progressively increase until a maximum intensity level is reached. It will then decrease progressively, ending with a low intensity.

Select the desired total length of your Power drill by pressing the up or down arrows under Duration. Scroll between 10 and 60 minutes.

Next, select the intensity by pressing the up or down arrows under Intensity. Swim current speeds range from 1 through 5.

NOTE: Swim drill Duration and Intensity operate between previously selected “Warm Up” and “Cooldown” cycles. Warm Up and Cooldown cycles are represented by gray bars on the outside of the white swim drill graph. Warm Up time is also shown as a countdown timer, located on the lower left of the progress bar.

Personalized Drills

Press the  (swim setting) icon to access the swim settings menu. Press the  (personalized drills) icon to view the personalized drill menu.

Your Swim Series spa allows you to create your own personalized swim drills to accommodate your training needs. The on-board controls can save up to three personalized training drills.

Start by selecting the drill location that you wish to configure by pressing the double arrow to the right of Personalized 1, 2, or 3. Enter the name of your personalized drill, using the keyboard on the personalized input screen. Once complete press the return button to proceed to the configuration screen.



Use your finger to drag each line up or down, to increase or

decrease the intensity levels.

The top of the graph represents swim current speed 5, while the bottom represents swim current speed 1.

Select the desired total duration of your Personalized drill by pressing the up or down arrows under Duration. Scroll between 10 and 60 minutes.

Next, select the intensity by pressing the up or down arrows under Intensity. Swim current speeds range from 1 through 5.

Press the  (go) icon to start the Preparation countdown previously configured and begin your selected swim drill. Pressing the  (pause/standby) icon will temporarily suspend operation, while pressing the  (stop) icon will stop the drill and revert to the previous setup screen.

Spa Settings

The settings on the Swim Series main control are navigated by the use of the  (Settings) button. One press gives you access to several menus where you can manage the specific settings of your spa. After pressing the Settings button you may access a submenu by pressing the associated icon.

Note that if an accessory is not present in your spa configuration, its menu will not appear. Refer to the following section to get details about the possible settings, accessories, and their detailed functionalities.

Water Care

The Water Care submenu will help you set up your ideal filtration and heating settings. Choose from Super Energy (default), Standard/Beginner, Away, Energy Saving, or Weekender, depending on your preference. Touch the mode name to select a setting. A confirmation message will appear to prevent inadvertent modification of water care settings. Touch the checkmark icon to confirm your choice or touch the x icon to decline.

In Super Energy, Away, Energy Saving, and Weekender modes, the water temperature set point will be reduced by 20°F* (11°C), which means that the heating system will not be engaged until the temperature falls to a point at least 20°F (11°C) below the set temperature. Use Standard/Beginner mode to maintain a constant water temperature at all times and days of the week.

Description of Heating Modes

NOTE: Your spa will come from the factory in "Super Energy" mode. See operation mode options below and select the best mode for your anticipated usage.

Energy Saver (factory default setting)

In Energy Saver mode the spa temperature set point will be reduced by 20°F (11°C) during peak daytime hours. Spa will heat to normal set point during evening hours, every day of the week. This is the default factory setting for new spas.

Suggested use: Use to save maximum energy and heat only during set filter cycles.

Economy time: Only heats during filtration cycles.

Filter cycle start time: 8:00 AM, duration 3 hours and 8:00 PM, duration 3 hours.

Standard

In Standard mode the spa will heat to the set point at all times and all days of the week. Spa will filter according to set filtration schedule.

Suggested use: Use to maintain readiness for use everyday at all times of day.

Filter cycle start times: 8:00 AM, duration 3 hours and 8:00 PM, duration 3 hours.

Vacation

In Vacation mode the spa temperature set point will be reduced by 20°F (11°C) at all times of the day and all days of the week.

Suggested use: Use when on vacation or not using the spa for longer than 2 weeks.

Economy time: Everyday of the week, 24 hours per day.

Filter cycle start time: 8:00 PM, duration 3 hours.

Super Clean

In Super Clean mode, the spa will heat to the set point according to the spa's standard configuration. Filtration times are double the standard, increasing both filtration and operation time of supplemental water care systems like EOS and others. The spa will heat to set point at all times and all days of the week.

Suggested use: Use to maintain readiness for use every day at all times of the day and increase water care system effectiveness.

Economy time: Not an Economy mode.

Filter cycle start times: 7:00 AM, duration 3 hours, and 6:00 PM, duration 3 hours.

Weekender

In Weekender mode the spa temperature set point will be reduced by 20°F (11°C) from Monday to Friday. Spa will heat to set point at all times of the day over the weekend (Saturday & Sunday).

Suggested use: Use when spa is used only on weekends and not on weekdays.

Economy time: Monday - Friday, 24 hours per day.

Filter cycle start time: 8:00 AM, duration 3 hours and 8:00 PM, duration 3 hours.

Default Settings: The Default Settings option will restore all

Water Care modes and schedules to the spa's default settings. You will be asked to confirm your choice.

Modifying Water Care Schedules

To modify a Water Care category, touch the pen icon at the right of the desired Water Care option to open the submenu.

Touch the Economy tab to change the economy setting and Filter cycle tab for the filtration settings (or schedules). You can add economy or filtration schedules by touching the title labeled "Add filter cycle" or "Add economy cycle". To delete a schedule, touch the garbage can icon at the right of the desired function title. Confirm your action when prompted.

You can modify the programmed schedules by selecting one and adjusting the schedule. You have several possibilities for the schedule (Mon-Fri, weekend, every day, or single days). The schedules will be repeated each week. The time and duration are set in 30-minute increments. When changes are done, press "confirm". If you don't want to keep any changes, press "cancel" or use the calendar icon to go back. Ensure that you have selected the desired Water Care mode in the main Water Care menu.

Maintenance Reminders

The Swim Series main control can be set up to remind you of several types of maintenance required on your spa, including rinsing the filter, cleaning the filter, changing spa water, and 2-year professional maintenance checks. Each task has its own standard duration, based on normal use, or you may adjust to fit your specific expected usage.

Access the Reminders submenu by pressing the Reminders icon in the Settings menu. Maintenance reminders allow you to verify the time left before maintenance is required, as well as to reset the time once a task is completed.

To reset a task, select it by pressing the title of the specific reminder, then confirm when prompted. Once you have confirmed, the task timer will be reset. You can also use the option "Reset Reminders" to reset all the reminders.

Set Date and Time of Day

Setting the correct date and time is important for settings to function as expected. Upon restarting your spa adjust the time format (24 hr. or AM/PM), change the year, date, and time as needed.

Within the Settings menu select "Date & Time" to access these submenus.

Select "Set Date" to adjust the year, month and day. Swipe up and down the column you want to change and select the desired value. When you are done, touch the Settings icon to save.

Select "Set Time" to change the hour, minute and time format. Swipe up and down the column you want to change and select the desired value. When done, touch the Settings icon to save.

Keypad Settings

In the Keypad submenu you can change the temperature unit settings or the language setting.

From the Config button, change temperature units by touching the "Temperature Units" title and then the desired unit of measurement.

Change the language setting by touching the "Language" title and

then selecting the desired language.

Standby/Lock

Standby mode allows you to service your spa. Pumps can be stopped for 30 minutes in this mode, and will automatically restart after. Select Standby mode by pressing the pause/standby icon. The home/status screen and normal spa function will resume after the 30 minute standby period.

The Lock option allows the user to partially or completely lock the keypad. Selecting the "Lock" option will lock all functions on the control while the "Partial Lock" option will allow jets, audio, and lights to remain functional. To lock the keypad select "Lock Settings" then select "Lock" or "Partial Lock" according to the functions you wish to lock. When asked, select a 4-digit code. The same code will be needed to unlock the keypad. To lock the keypad again, you will be prompted to select another 4-digit code.

The keypad can be unlocked with a universal unlock code (3732) or by a reset of the keypad. When Full Lock is selected, all functions are locked. In Partial Lock, you may activate accessories, but spa settings may not be changed.

Electrical Configuration

IMPORTANT: Please do not make changes in this section unless you are a qualified electrician.

In this section you can change the low-level configuration, as well as modify the number of phases and the input current value.* Please refer to the diagram on the spa control center box, located inside of the equipment compartment, for the default configuration of your specific spa model. Once the modification is completed, confirm selection when asked and touch the Settings icon to return to the Settings menu.

NOTE: On initial connection the installer is prompted for electrical configurations. The Low-Level setting is selected by the installer. The Phase and Amperage is set automatically. Default settings should be confirmed by the installer to match the actual phase and amperage at the spa's installation location. In rare occasions it may be necessary to adjust the Phase and Amperage setting to match the actual service available at the installation location using the instructions above.

** Depending on the pack configuration, a code may be required to modify the low-level number. This code is 5555.*

About

This section displays technical information about the Swim Series control software version and applicable revisions of the different components of your system.

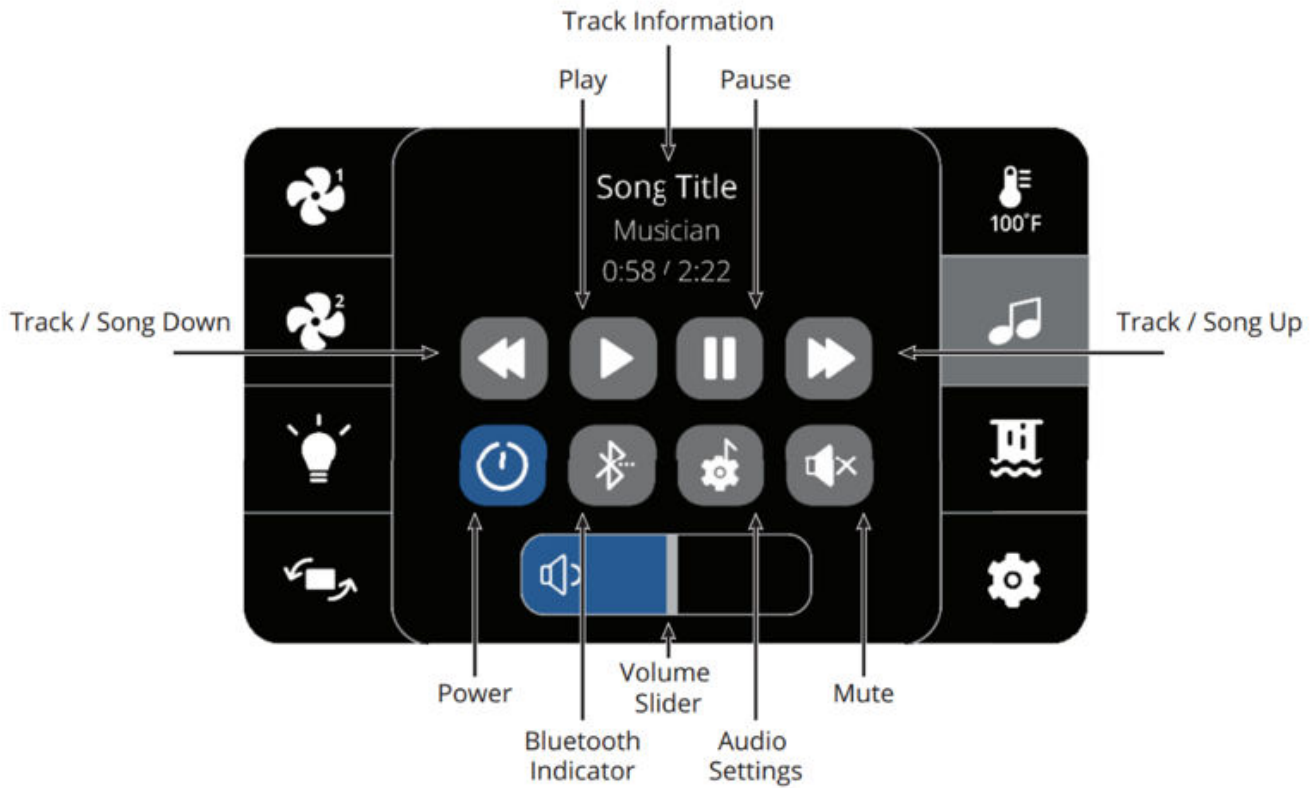

Audio System Controls (Optional)

Press the Audio icon to access “in.stream 2” player controls.

If you are using a device with Bluetooth technology, it must be connected for functions to work. Use code 5555 to pair.

Speakers settings: Move the sliders to adjust the Balance, Fader and Subwoofer settings. The Fader and Subwoofer sliders will only appear in the Speakers menu if the corresponding speakers are available.

Source menu: To change the audio source, simply tap on the “Audio Settings” menu and select desired audio source or device. Note that only the sources available on the Swim Series Audio will be displayed in the source menu.

Connect Bluetooth: The first time you use your Bluetooth device with a Swim Series Audio system you must first “pair” or connect your device to the spa audio system according to the standard functionality of your specific device.* Each device must be connected separately. Use code 5555 to pair.

Disconnect Bluetooth: If a device with Bluetooth technology is connected to the Swim Series Audio, you can disconnect it by pressing the Disconnect button at the bottom of the screen. Doing so will also prevent the audio system from automatically reconnecting to this specific device until it has been reconnected using the device itself.

For proper function, place your Bluetooth device within 20 feet (6 meters) of your spa. The device should have “line of sight” to the spa control panel / equipment door area.

NOTE: Certain house construction materials and other obstructions can impair Bluetooth connectivity. You may need to experiment with where to place your device for best results.

JETPAKS & JETS

Interchanging JetPaks

Step 1: Place the spa in Standby mode by pressing the (pause/standby)  icon, located in the setting screen. This will prevent the pump(s) from activating while JetPak are being moved. Normal spa function will resume by pressing the X (cancel button) or automatically after a 30-minutes.

Step 2: Remove the JetPak from the pod by sliding a hand into the recess between the top of the pillow and the spa. Push the JetPak away from you and toward the inside of the spa.



Step 3: Place the JetPak in the desired location in the spa. Align the JetPak in the JetPod area. Seat the blue gasket at the bottom of the JetPak into the manifold and secure the JetPak in place by pulling (if outside spa) or pushing (if inside spa) firmly into place until you feel the J hook engage to lock the JetPak into place.

NOTE: Pushing or pulling the JetPak into place with too much force may damage the hook or the JetPak.

Headrest Removal

Step 1: Remove the pillow by placing your hands under the front right side of the pillow. Gently pull to release the pillow from the snap cap.



Step 2: At the front of the snap cap, grasp light blue wedge and pull up. Remove completely.



Step 3: Grip the internal JetPak cap assembly and pull up to remove completely from the Jetpak manifold.



Step 4: To put back together, align the internal JetPak cap assembly ears with JetPak manifold and press down until it snaps into place. Slide light blue wedge back into the slot and push down until it clicks.

Step 5: Align the pillow buttons with holes located on the top of the snap cap and press firmly until you hear a click.

Adjustable JetPak Valves & Adjustable Jets

The jetting options offered as part of the JetPak Therapy System, as well as additional therapy jets throughout your Swim Series model may be adjusted to provide an optimal therapy experience.

Adjusting JetPak Flow

To adjust the water flow to the entire JetPak turn the valve located in the lower portion of each JetPak.

- To increase jet water pressure, turn the valve handle counter clockwise.
- To decrease jet water pressure, turn the valve handle clockwise.

The JetPak control valve is adjustable with a range of about 120 degrees between the on and off positions.



Adjustable Jets

To adjust the water flow to adjustable jets in other locations throughout your Swim Series spa turn the inner jet face.

- To increase jet water pressure, turn the jet face clockwise.
- To decrease jet water pressure, turn the jet face counter clockwise.



NOTE: Not all jets are adjustable. Certain jets throughout your Swim Series spa may be fixed in the on position by design and will not be able to be adjusted. Attempting to turn or manipulate these jets may cause damage to the jet itself or the spa. All adjustable jets will turn easily with very little effort. Never attempt to turn a jet or jet face with undo force or any type of tool. If you believe a jet that is intended to be adjustable is stuck contact your Authorized Bullfrog Spas Dealer for service.

WATER CARE

Chemical Water Sanitizers

Properly maintaining your spa water is very important to ensure enjoyment in using your spa and to maximize spa shell and equipment life. Properly maintaining your spa water chemistry will require regular attention to prevent poor water quality, potential unhealthy conditions, and possible damage to your spa.

Water chemistry will vary by source and location. Please refer any water care questions or concerns to your local Authorized Swim Series Dealership. Your Dealer can recommend the correct products and procedures for safely sanitizing and maintaining your spa according to local water chemistry, regulations, and your specific circumstances.

Spa Water Care

Consult your local Authorized Swim Series Dealership for specific options for maintaining water quality. Your Authorized Swim Series Dealer can recommend the correct products and procedures for safely sanitizing and maintaining your spa according to local source water chemistry differences, regulations, and your specific circumstances.

CAUTION:

- Always follow chemical manufacturers' instructions and never mix chemical sanitizers.
- Use an accurate test kit to perform all chemical tests.
- Add chemicals directly to the spa water, evenly spreading the chemicals over the surface of the water with the jets operating, or use an appropriate feeding or metering device.
- Check chemical levels often.
- Run the pumps on high speed, with the cover removed, for at least 30 minutes after applying any chemicals to mix adequately and avoid potential damage to equipment, accessories, or surfaces.
- Names of spa chemicals often vary from one manufacturer to another. Please contact your authorized Swim Series Dealer if you have any questions.

Starting the Spa with New Water

IMPORTANT: Soft or hard source water may require special attention. Never fill the spa with soft water unless an appropriate mineral supplement is immediately added. Or, if your source water is extremely hard or contains a high concentration of metals, a pre-filter may be required. It may also be possible to either dilute the water's hardness by blending the water no more than 50/50 with softened water from a water softener, or by the addition of a special water softening chemical. For more information and recommendations contact your Authorized Swim Series Dealer.

Step 1: If possible, have your authorized Swim Series Dealer test the calcium hardness (CH) of your spa source water. If necessary, make appropriate preparations for your specific water conditions following your Dealer's recommendations.

Step 2: Fill spa according to instructions provided in Filling

Your Spa. Once filled, add the prescribed dose of water clarifier to remove micro-particulates. Depending on your local water chemistry, it may also be encouraged to add a prescribed dose of stain and scale inhibitor as you fill. This can provide initial protection against metallic staining and mineral scaling.

Step 3: Test and **adjust the total alkalinity (TA)**. The TA should measure 125 to 150 parts per million (PPM).

Step 4: Test and **adjust the pH**. The pH should measure 7.4 to 7.6.

Step 5: **Add the appropriate sanitizer.** If you applied water clarifier, allow water to circulate for one hour before sanitizing. To sanitize add ½ teaspoon of granular chlorine for each 200 gallons (909.2l) of spa water.

After several hours, check sanitizer level with a test kit approved by your Authorized Swim Series Dealer and adjust dissolved sanitizer, if necessary, to the following levels:

- Chlorine Level: 3.0-5.0 PPM (parts per million).

Step 6: Startup water chemistry is now complete. However, it may take additional time for the filter to completely clear the water.

Maintaining Sanitizer & pH Levels

It is important to test and adjust the sanitizer and pH level of your spa on a frequent basis. If the spa is used 0-3 times weekly, we recommend that you test the water a minimum of 2 times a week. If the spa is used 3 or more times weekly test the water one additional time per use. Approved test kits and supplies are available from your Authorized Swim Series Dealer.

pH Control: Proper pH balance is extremely important in controlling bacteria, providing water that is comfortable to the user, and preventing damage to the spa and equipment. The pH scale ranges from 0-14. Levels of pH less than 7.0 are acidic while pH levels greater than 7.0 are basic. The proper pH range for a spa is 7.4-7.6.

High pH levels (greater than 7.6): Can cause scale build-up on the spa and its equipment, cloudy water, a prematurely dirty filter, and less effective chlorine sanitation. To correct high pH levels, add a Dealer-approved pH decreaser.

NOTE: Never use Muriatic or Hydrochloric acid to adjust pH as it can damage the spa shell and surroundings.

Low pH levels (less than 7.4): Can cause discomfort to the spa users and corrosion to the spa equipment. To increase pH levels, add a Dealer-approved pH increaser.

IMPORTANT: Always test, and adjust the pH level to the correct range before you test and adjust the sanitizer level.

Sanitation: Spa water sanitizers kill microorganisms and keep spa water clean and safe. Granular chlorine (Dichlor) is both effective and safe. This is the sanitizer recommended by Bullfrog Spas. Chlorine and bromine are the only EPA approved sanitizers in the USA. Other countries permit chlorine only. Please refer to local and national health codes for approved sanitizers in your

area. Bullfrog Spas does not recommend the use of bromine in Swim Series spas as, over time, it may damage the Non-slip Aquatic Surface coverings.

WARNING: Trichlor chlorine tablets should never be used in an acrylic spa. Dissolve rate, potency and the extreme low pH of this chemical can cause severe damage to the spa surface and components. Use of trichlor chlorine tablets will void the Swim Series warranty.

NOTE: Dichlor tablets are also not recommended as a sanitizer in Swim Series spas unless an appropriate feeding or metering device is used and the water is frequently tested and monitored. Tablets dispensed incorrectly can lead to excessive chlorine in the spa, which can cause surface damage and component failure. Bromine tablets are not recommended due to their potential to damage the Non-slip Aquatic Surface used in Swim Series spas.

With each sanitizer test, use Chlorine to maintain the following levels:

- Chlorine Level: 3.0 to 5.0 PPM (parts per million)

Super Sanitation or Spa Shock

Normal sanitation does not eliminate non-filterable contaminants, such as perspiration, laundry detergents, oils, hair products, etc., which may build up in the water. These substances may cloud the water, create surface films, and can interfere with sanitizer effectiveness. Super sanitation in order to remove such contaminants is achieved by “shocking” the spa water with a non-chlorine shock (Potassium Peroxymonosulfate), enhanced shock, or granular chlorine (Dichlor).

Super Sanitize the water once a week by adding one of the following:

- Non-chlorine shock 5 teaspoons (25ml) per 200 gallons (909.2l) of water
- Enhanced shock 3.6 teaspoons (18ml) per per 200 gallons (909.2l) of water
- Granular chlorine 2 teaspoons (10ml) per 200 gallons (909.2l) of water

NOTE: Your Swim Series spa may be outfitted with the Clear Comfort for Bullfrog Spas Premium AOP System (CCW25 model). This system may significantly reduce the need to super sanitize and/or frequency required.

Total Alkalinity (TA): Total alkalinity (TA) is the quantitative measurement of alkaline components (carbonates and bicarbonates) present in water to act as a buffer against rapid pH changes. Proper total alkalinity levels are important to ensure optimal chemical balance in spas. Low TA can cause pH to be unstable. To correct low TA, add a Total Alkalinity Increaser. High TA can cause the water to be scale forming, cloudy and corrosive to the spa and its components, as well as other pH related problems. If the spa water has high TA, contact your Authorized Swim Series Dealer.

Calcium Hardness (CH): Calcium hardness (CH) is the measure of dissolved calcium in the water. Low CH (soft water) can stain the spa surface as well as cause corrosion to the spa and its equipment. To correct low CH, add a calcium hardness Increaser.

High CH (hard water) can cause cloudy water as well as rough scale build-up on the spa surface and equipment. If the spa water has high CH, contact your Authorized Swim Series Dealer.

Stain and Scale Control: Stain and scale problems are common in hot water environments. To help prevent and control staining and scaling, use a stain and scale inhibitor per the manufacturer’s instructions. Add stain and scale inhibitor 3-4 days after super sanitation.

Foam Control: Spa water may foam when agitated. This is usually due to the presence of untreated organic oils, lotions, soaps, and/or detergents. For a temporary fix use an anti-foam additive available through your Authorized Swim Series Dealer. To more permanently control excessive foam follow the instructions under "Super Sanitation or Spa Shock." This process should help break down and oxidize the substances that lead to excessive foaming.

NOTE: It is recommended to rinse off sweat, oils, lotions, shampoos, soaps, and/or detergents from your body and swimwear prior to entering the spa. Many people will maintain designated spa swimwear that is rinsed in clean water after each use to avoid accumulating detergents in the laundry.

Cloudy Water Prevention and Control: There are two basic reasons that spa water becomes cloudy. First, non-filterable liquid waste (e.g. perspiration) has contaminated the water. To remove these substances, Super Sanitize the water. Second, non-filterable micro-particulate waste (e.g. dust) has contaminated the water. To remove these substances use a Water Clarifier as per the manufacturer’s instructions.

WARNING: During water care processes, or at any other time, an empty spa (spa without water in it) must not be left exposed to sunlight as shell damage may occur. Once the spa is unwrapped, fill spa with water immediately or shade the spa with cover or wrapping to prevent direct exposure to sunlight.

Water Chemistry Troubleshooting

Prior to each spa use, check the water. If the water appears cloudy, off color, has significant surface foam, or smells of excessive chlorine, the water needs to be treated or drained. Using the spa in these conditions could result in skin or lung irritation.

For assistance in handling challenges with spa water chemistry, contact your Authorized Swim Series Dealer or another service center capable of performing a computerized water analysis.

Freeze Protection

NOTE: Your spa is equipped with a freeze protection mode. When potentially freezing outside temperatures are detected your control system will turn on to check the water temperature. If heating is necessary to protect from freeze conditions your spa may turn on and heat to a safe temperature. A notification will display on the main control screen indicating this mode is engaged.

Supplemental Water Care

Supplemental water care systems may be available for your Swim Series spa. These systems are not intended to replace an approved water sanitation program, however, they may reduce the amount of sanitizer required to adequately maintain your spa water.

Water Filtration

Your Swim Series spa features the Simplicity filtration system for maintaining clean and clear water with a minimum of effort.

Replacing the Filter

To ensure proper cleaning and function of your Swim Series spa your Simplicity flat filters will need to be replaced regularly. It is recommended to replace each filter every 4 weeks, or as needed, depending on use and water characteristics. To maintain warranty protection, use only genuine Bullfrog Spas, Simplicity brand filters. Use the following procedure to replace your filter(s):

CAUTION: Never operate spa with the filter removed.

Step 1: Place the spa in Standby mode by pressing the  (pause/standby) icon. The home/status screen and normal spa function will resume after a 30 minute standby period.

Step 2: Locate the JetPak in front of each of the Simplicity filter housing (this is usually the first JetPak to the right of the main control). Remove the JetPak following the instructions in the section titled "Interchanging JetPaks."

Step 3: Remove the Simplicity filter holder. Reach down into the jet pod and grab the handle, push toward the middle of the spa and lift up to remove from the housing. Place holder on a flat surface with the filter up.

Step 4: Remove and replace the filter. To remove the Simplicity Filter, compress the pleats and push forward slightly. Lift the edge of the filter past the capture tab. This will allow you to lift the used filter from the filter holder. Discard the used filter. Reinsert a new Simplicity filter into the holder. Orient the filter media with the glue lines facing upward. Slide one end of the filter under the retention tabs and then press in and down to tuck the remainder of the filter into the frame.

Step 5: Reinstall the Simplicity filter holder back into the pod with the handle upward. Align the bottom of the unit in the housing with the handle up and snap the filtration unit into place in the housing with a back and down motion.



Step 6: Replace the JetPak and Snap-Cap following the instructions in the section titled "Interchanging JetPaks."



Step 7: Return spa to normal operation by pressing the  (cancel) icon on the main control to cancel Standby mode.

Cleaning Filter Intakes

Your Swim Series spa features dual screened filter intakes with removable screened baskets to catch and filter larger objects such as leaves and other debris. To ensure proper function of the

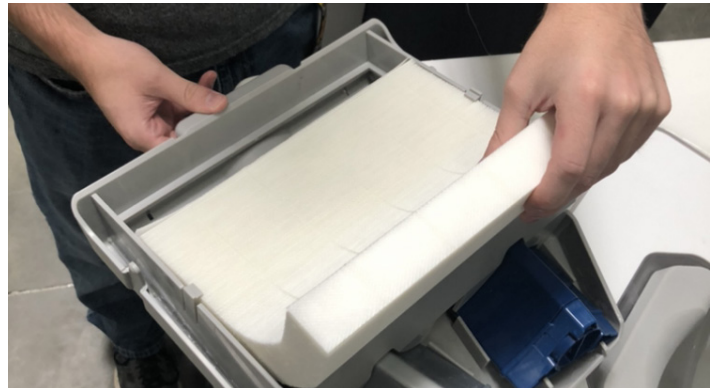

Simplicity Filtration System it is important to periodically access these baskets to dispose of any accumulated objects.

CAUTION: Never operate spa with filter screens removed.

Step 1: Place the spa in Standby mode by pressing the  (pause/standby) icon. The home/status screen and normal spa function will resume after a 30 minute standby period.



Step 2: Remove the filter grate by pressing both of the locking tabs on each side outward while pulling the grate away from the intake fixture and spa wall. Set grate aside.



Step 3: Remove the filter basket assembly by gripping the basket handle and pulling outward.



Step 4: Once removed, simply remove any debris from the basket by hand or by inverting and tapping the basket to free stuck on materials. Repeat steps 2-4 for the second grate and basket.



Step 5: Return baskets to their original installed location inside the filter intake fixture and replace grate assembly by snapping into place.

Step 6: Return spa to normal operation by pressing the  (cancel) icon on the main control to cancel Standby mode.

Changing Spa Water

Over time as you use your spa, non-soluble substances from use and water care may accumulate, making maintaining the water more difficult. Rinsing bathing suits and showering without soap prior to entering your spa will increase the life of your spa water, however, depending upon usage, the spa water will need to be changed as balancing pH and sanitizer levels become difficult to manage. In Swim Series spas this is recommended every 6 months or as needed. When changing water, remove all JetPaks. Clean the shell and jet pod areas with a spa surface cleaner. See Spa Shell Care. Clean the other areas of the spa, including JetPaks, with a spa surface cleaner as necessary.

IMPORTANT: Drain your spa to an area or drain that can handle a large quantity of water at a rate the area or drain can accommodate. If draining water onto vegetation such as a lawn, make sure that the sanitizer level (chlorine) of the water is less than 0.5 PPM.

WARNING: Avoid drainage that can lead into basement window wells or any other area where damage could occur.

To Drain Your Spa :

Step 1: Turn-off main electrical breaker to spa.

Step 2: Locate drain below equipment compartment door.

Step 3: Pull the drain out toward you with a slight clockwise turn. Use pliers for an adequate grip if needed.



NOTE: Drain is fully extended at approximately 2 inches (5 centimeters).

Step 4: Remove drain cap by turning counter clockwise.

NOTE: The drain spout will not drain when fully extended.

Step 5: Attach a standard garden hose to threaded drain end. With hose attached, push the drain spout in halfway to actuate the flow of water through the drain.



NOTE: Depending on the size of your model and the capacity of your hose, the spa will drain about 5-10 gallons (20-40 liters) per minute. Ensure that drainage flows into a waste water or French drain with adequate capacity or free flows away from structures, window wells, or basement entries to an open area that can absorb or hold for evaporation the entire capacity of your spa.

Step 6: Once fully drained, pull the drain spout out all the way, remove hose, replace the drain cap, and push the drain stem and cap in all the way. A slight rotation may be required to push drain assembly in fully.

To Refill Your Spa:

WARNING: When refilling the spa, always super sanitize the new water by adhering to the instructions in the Spa Water Care section.

Follow instructions in Spa Filling and Starting the Spa with New Water

SPA MAINTENANCE

Spa Surface Care

IMPORTANT: Your spa cover is an essential part of the spa system. In order to protect spa surfaces, ensure safety, and to provide the highest possible efficiency. Ensure the cover is in place at all times except during spa use.

General Cleaning

For normal cleaning of a dry spa, use a mild, diluted, dishwashing soap, window cleaner, or specific spa surface cleaning products recommended by your local authorized Swim Series Dealer. For stubborn stains, use a mild acrylic cleaner or a mild detergent. To apply these cleaners, use a soft, damp cloth or sponge. Rinse well and dry with a clean cloth. To clean hard water stains, remove light scratches and protect your spa shell, contact your Authorized Swim Series Dealer.

Cleaning a Surface Buildup Line

With normal use of the spa, oils, lotions, and hair products can build up on the surface of the water in small amounts. This could leave a line around the inside perimeter at the water level. This buildup is easily removed using a spa surface cleaner. Avoid using cleaning agents that leave soap residue in the water.

WARNING: Never allow your spa surface to be exposed to alcohol, acetone (nail polish remover), nail polish, dry cleaning solution, lacquer thinners, gasoline, pine oil, abrasive cleaners, or any other household chemicals other than those listed. These chemicals void the warranty.

JetPak Plumbing Care

For optimum spa care, each time the spa water is changed, remove all JetPaks. Clean the back manifold area on with a spa surface cleaner and a long, soft bristle brush. For cleaning the JetPak acrylic surface, refer to Spa Shell Care

Spa Cabinet Care

Swim Series cabinets and cabinet components are made to provide many years of maintenance-free service. For normal cleaning, use a mild dishwashing soap applied with a soft damp cloth or sponge. Rinse with a garden hose. For stubborn stains, contact your Authorized Swim Series Dealer.

Spa Cover Care

WARNING: A non-secured, improperly secured, or damaged cover may pose a safety threat to children and may also cause damage or injury if blown off by wind. Always remove entire cover before using the spa and secure the spa cover with all security clips immediately after use.

IMPORTANT: Do not stand, sit, or place any item on the cover that could dent or damage it. Gently remove snow accumulations over 2 inches (5cm) to avoid damage caused by the weight of the snow. Always secure the cover with all of the cover locks when not in use, whether empty or filled.

Cleaning the Spa Cover

Cleaning your spa cover is recommended at least monthly, or as needed. Use the following procedure.

Step 1: Use a leaf blower to remove all dust and debris from dry cover fabric. A utility vacuum with soft brush attachment may also be used.

Step 2: Use a garden hose and nozzle to spray entire cover down with water. Rinse all traces of dirt, sand, and debris from cover. Do not touch cover fabric or rub anything on it while wet.

Step 3: Tip cover approximately 45 degrees using cover lift or an assistant to allow standing water to drain. Allow cover to air dry completely.

Step 4: Ensure all cover clips are secured completely.

NOTE: If water doesn't bead on the cover surface and/or cover looks darker in some areas, use an outdoor fabric conditioner (never petroleum based) to restore water resistance. Contact your Authorized Swim Series Dealer for product suggestions. Do not use any type of conditioning product on the underside of your cover.

NOTE: If more thorough cleaning is required, add 2 ounces of mild soap to 1 gallon of warm water. Clean the cover fabric with a soft brush. Rinse thoroughly with cold water and follow steps 3 and 4 to dry and secure. Once dry you may use an outdoor fabric protectant to recondition cover fabric according to your Authorized Swim Series Dealer's instructions.

LED Light Replacement

Contact your Authorized Swim Series Dealer for repair.

Clear Comfort for Bullfrog Spas AOP System Maintenance

Swim Series spas feature the premium Clear Comfort for Bullfrog Spas AOP System (CCW25) installed standard. The Clear Comfort AOP system supports water care with a powerful advanced oxidation process (AOP). The system operates automatically during filtration cycles. You can confirm normal system operation by opening the equipment door, locating the system control unit and cartridge, and viewing the color of the status lights. There is a status light on the CCW25 control unit (gray box) and one on the Clear Comfort for Bullfrog Spas CCW25 cartridge (blue). A green light on the control unit indicates normal operation. No status light indicates a power interruption or malfunction. If this is the case, contact your Authorized Swim Series Dealer for service. A blue light on the cartridge indicates normal operation at full capacity. When the light on the cartridge changes to yellow, it is time for a cartridge exchange. Depending on use, it is expected to be necessary to exchange your cartridge about once per year with a Clear Comfort for Bullfrog Spas CCW25 cartridge available at your Authorized Swim Series Dealer.

Clear Comfort for Bullfrog Spas CCW25 Cartridge Exchange

Follow the instructions to exchange your Clear Comfort for Bullfrog Spas CCW25 cartridge.

Turn off power to the spa at the breaker. **NOTE:** Never attempt to service the CCW25 unit if wet. To access the Clear Comfort cartridge follow the instructions in "Removing & Installing the Equipment Door" to access the equipment area. Locate the Clear Comfort for Bullfrog Spas control unit and cartridge.

Ensure power to the CCW25 controller and cartridge are off by ensuring that both status lights are not illuminated.

Disconnect air tubing (2 lines) from the barbed fittings at the bottom of the CCW25 cartridge by pulling the air line from the barbed fitting.

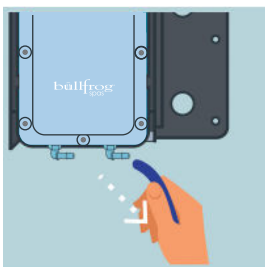

Press and hold the metal release tab at the bottom right of the controller to free the cartridge.

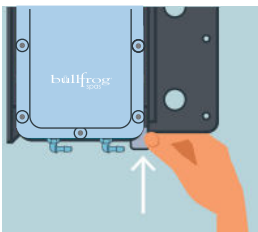

Pull the CCW25 cartridge unit down until the indented slots in the cartridge align with the guide ridges in the controller (about 1 inch/2.5 cm).

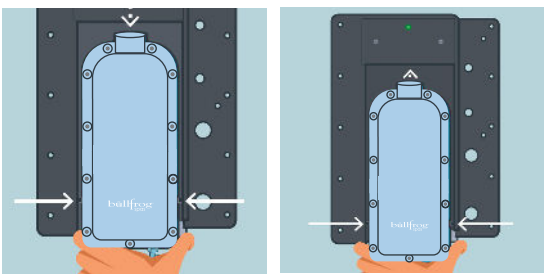

When slots in the cartridge align with the guides in the controller, pull the cartridge towards you and free it from the unit.

Repeat these instructions in reverse to install the new cartridge. Be sure to use Clear Comfort for Bullfrog Spas CCW25 cartridges, available at your Authorized Bullfrog Spas Dealership. Other Clear Comfort cartridges are not configured for and will not function correctly in a Clear Comfort for Bullfrog Spas unit. For proper recycling, please return your used cartridge with the pre-paid label and packaging provided with your new cartridge.

Other Care

Cleaning & Protecting Headrests

Regularly clean all headrests with mild soap, water, and a clean cloth. Monthly, treat headrests using a non-petroleum-based conditioning product as recommended by your Authorized Swim Series Dealer. This will help maintain water resistance, surface integrity, and luster of the product.

IMPORTANT: Remove the pillows during and after shock treating the spa water, super sanitization, or when sanitizer levels are high. Leave cover open for at least 30 minutes after shocking to ensure pillows are not affected by gasses common during oxidative processes.

NOTE: Pillow discoloration and/or degradation is accelerated by high sanitizer use, improper ventilation after shock treatments, and is not covered by the Swim Series Warranty.

Vacuum the Spa

Debris carried by wind and/or tracked in by users will occasionally accumulate on the bottom of the spa. The filtration system will remove smaller objects. Larger objects or heavy debris can be removed with a hand held spa vacuum available at your Authorized Swim Series Dealer.

Low-Use or No-Use Periods

For periods of no or low use consider the following:

No Use for Two to Six Weeks

If the spa will not be used for at least two weeks, lower the temperature to the lowest setting of 80 F (26°C) and use Super Energy Saver mode. Lowering the temperature will cut the cost of operation during this time. Remember, you will need to adjust the temperature setting back to your desired setting 6-12 hours before use depending on outside temperature.

IMPORTANT: For all no-use periods, and on a weekly basis, be sure to visually check that the spa is functioning correctly and maintain the spa water as per the instructions under the Spa Water Care section. Not doing so may lead to corrosion, staining, and/or scaling to the spa and its equipment. During periods of freezing temperatures, a spa that has malfunctioned may be subject to damaged plumbing or equipment as a result of ice buildup within the spa. If the spa cannot be checked and maintained on a weekly basis consider winterization following the recommendations below.

No Use for Over Six Weeks

When you are not planning to use the spa for six or more weeks, or when someone is not able to maintain the spa on a weekly basis, you should use Away mode. For extended absences you may also choose to winterize the spa. Follow winterization recommendations below:

Winterization

WARNING: Prior to winterizing your spa, it will be necessary to super sanitize the spa water as per the instructions in the Spa Water Care section. This procedure will help prevent the growth of microorganisms in any areas of plumbing that may not be fully free of water after you drain your spa for its period of winterization.

NOTE: Your spa is equipped with a freeze protection mode. When potentially freezing outside temperatures are detected your control system will turn on to check the water temperature. If heating is necessary to protect from freeze conditions your spa may turn on to circulate water and heat to a safe temperature. A notification will display on the main control screen indicating this mode is engaged.

Step 1: Drain the spa following the instructions in Changing Spa Water.

Step 2: Open all valves on each JetPak to allow the water to drain from each JetPak as you drain the spa. Once the water is completely out of the spa then close each JetPak valve before proceeding to step 3.

Step 3: Use a wet/dry vacuum to clear the plumbing lines. Place the vacuum nozzle completely over each of the jets in the wall of the spa.

Step 4: Remove the drain plug from the pump(s) and loosen all PVC pipe unions in the equipment compartment. Do not replace the plugs or tighten the unions until the spa is de-winterized.

Step 5: Clean the spa shell and JetPaks following instructions in Spa Surface Care.

Step 6: Remove filter cartridge(s). You may either replace with new filters during dewinterization or allow to air dry, and reinstall.

Step 7: Secure the cover to the spa utilizing the locking system. You may consider additional tie downs if winds are a possibility. Remove snow off the cover following each snow storm. In areas where heavy snow is anticipated, or if you will be away, place plywood (or its equivalent) over the spa cover to assist in distributing and supporting the anticipated weight of the snow.

Step 8: Use a wet/dry vacuum to remove the remaining water out of pipes by placing the vacuum hose over each filter and JetPak supply manifold at the bottom of each jet pod.

Step 9: Ensure each JetPak valve is closed. Plug off each filter opening using a tennis ball. Or pour ½-1 gallons (5-9 liters) of RV antifreeze into each filter opening.

NOTE: RV antifreeze is nontoxic and does not require evacuation at start up.

Spa De-Winterization

To de-winterize the spa, reverse the winterization procedure and restart the spa according to the instruction in Filling the Spa, Start Up, and Starting the Spa with New Water.

WARNING: Whenever refilling the spa, it will be necessary to Super Sanitize the new spa water. Instructions are found in the Spa Water Care section.

Removing & Installing the Equipment Door

Door Removal

Step 1: Remove trim strips from trim channels by pulling carefully and firmly, working from the bottom of the trim strip to the top. Place trim strips aside.



Step 2: Remove door - Carefully pull bottom of door out toward you. Carefully grab the bottom corner of the door and pull it out enough that you can slip your other hand in behind the side of the door about 4-5 inches (10-13 cm) up from the bottom. From there you will pull the door firmly away from the spa until the snap on the door pulls out of the snap feature in the rib. Continue to pull the door away until the second snap on the other side pulls out. The door can then be dropped out of the groove on top and removed from the spa.



Step 3: Electrical Disconnect – be sure to disconnect any lighting or any other electrical wiring that is mounted onto the door before completely removing it.

Step 4: When removed, lean door against spa.

Door Installation

Step 1: Slip the upper lip of the door into the top behind the lip of the spa. Lower the door while gently pushing on it until you feel the snap channel line up with the snap features in the support studs. Starting from one side, apply firm pressure directly inward over the snap feature to force the first snap into place. Then force the other side of the snap channel into the snap feature in the same manner until the door is secured.



Step 2: Replace trim strips by snapping each strip carefully into the trim channel.

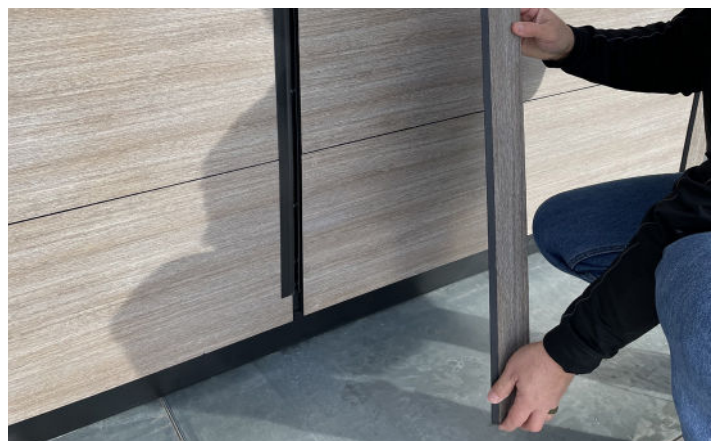

FITNESS & RELAXATION ACCESSORIES

Accessory Instructions

Your Swim Series spa comes ready to accept a variety of Swim Series brand fitness and therapy accessories (optional). These include the Strength & Stretch Fitness Kit, Zero Gravity Spa Hammock, and Swim Tether Kit. As these accessories may be ordered and shipped with your spa, an overview of their function is provided here. In addition, please refer to any instructions or warnings included within the packaging of each specific accessory.

WARNING: Installation or use of a Swim Series accessory in a manner that does not comply with these instructions and the accessory's intended use may be dangerous and could void your Swim Series spa warranty.

INSTRUCTIONS FOR USING YOUR SWIM SERIES™ FITNESS KIT

Strength & Stretch Fitness Kit:

- | | |
|--------------------------|--------------------------|
| 1 - EXPANDABLE ROW BAR | 1 - FITNESS BAND STRAP |
| 1 - LARGE FITNESS BAND | 2 - FITNESS BAND HANDLES |
| 4 - MEDIUM FITNESS BANDS | 2 - FITNESS ANKLE CUFFS |
| 2 - SHORT FITNESS BANDS | 1 - SWIM ACCESSORY BAG |

INSTRUCTIONS FOR USING YOUR SWIM SERIES™ ROW BAR

Step 1:

Loop the Large Fitness band (F) through the mounting ring at the end of the Fitness Band Strap (C).

Step 2:

Attach Large Fitness band (F) to the Anchor Points (G).

Step 3:

Connect the Clip end of Fitness Band Strap (C) to the Short Fitness band (D).

Step 4:

Connect the Short Fitness band (D) to the connector loop, located at the center of the Row Bar (E).

Step 5:

Connect one side of each of the Medium Fitness bands (B) to the connector loop, located at the center of the Row Bar (E).

Step 6:

Connect the opposite side of each Medium Fitness bands (B) to Anchor Point (A).

Step 7:

Adjust the length of the Fitness Band Strap (C) to provide the ideal amount of reach and resistance.

Step 8:

Fitness Equipment should be removed from the spa after each use and hosed off with regular tap water.

*Always inspect all parts prior to installation, immediately replacing any worn or damaged parts.

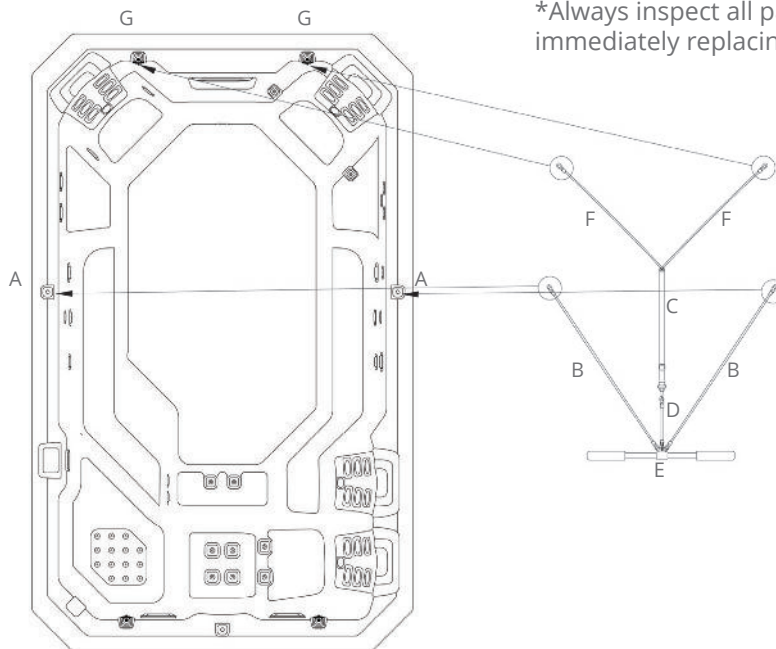

Key

- A. Anchor Point
- B. Medium Fitness Band
- C. Fitness Band Strap
- D. Short Fitness Band
- E. Row Bar
- F. Large Fitness Band
- G. Anchor Point



INSTRUCTIONS FOR USING YOUR SWIM SERIES™ FITNESS BAND HANDLES

Step 1:

Connect short fitness band (C) to handle (B), and repeat so both bands each have one handle connected.

Step 2:

Attach each of the remaining ends of fitness bands to an anchor point (A) on the lounge end of the Swim Series spa.

Step 3:

Sit in exercise seat (D) and press handles forward for a shoulder and upper body workout.

Or

Stand and turn, bracing feet in the footwell to pull handles back for a back-focused workout.

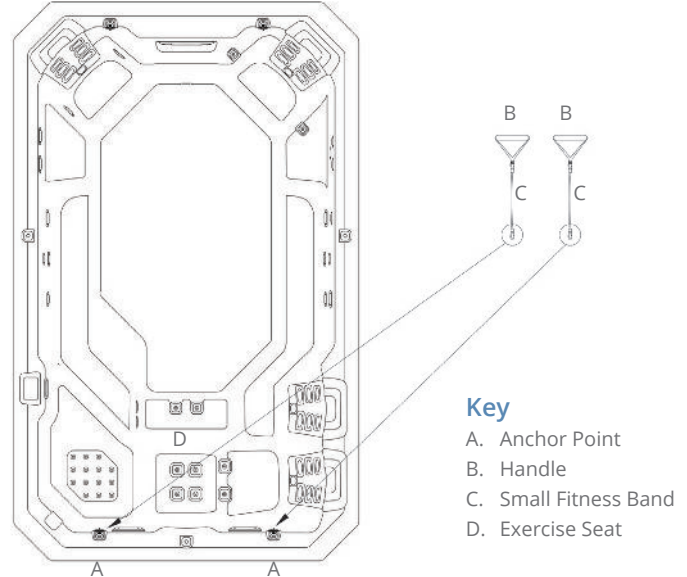

INSTRUCTIONS FOR USING SWIM SERIES™ ANKLE STRAPS

Step 1:

Choose the longest-length fitness band (C) and attach it to an ankle cuff (B). Repeat with the second ankle cuff and the same length of band.

Step 2:

Attach the other end of either fitness band to an anchor point (A) at the propulsion end of the Swim Series spa.

Step 3:

Place one ankle cuff around each ankle, and stand.

Step 4:

Use the bar (located above the water level, center of the propulsion end) to keep yourself balanced against the resistance bands.

Step 5:

Raise and lower each leg in a scissoring motion to work out inner and outer thigh and glute muscles.

Step 6:

Be careful not to slip! Enjoy your workout.

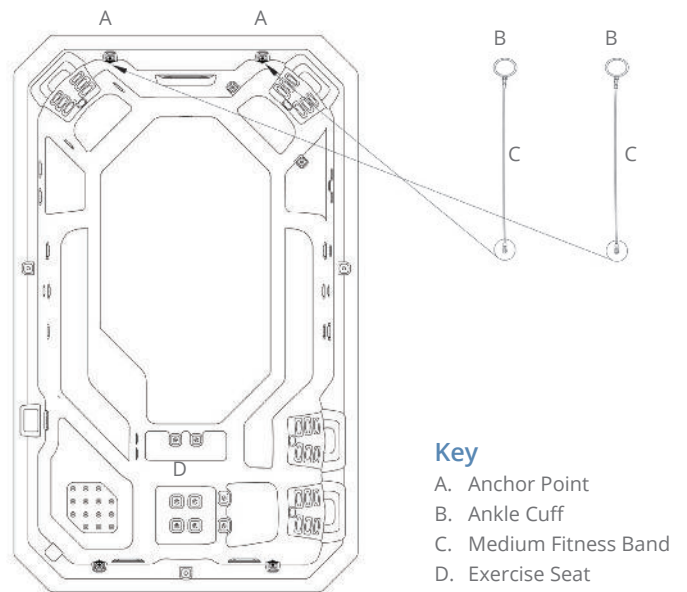

SWIM
SERIES™

bullfrog
spas

INSTRUCTIONS FOR USING YOUR SWIM SERIES™ ZERO GRAVITY SPA HAMMOCK

Zero Gravity Spa Hammock:

- | | |
|--|------------------------|
| 1 - HAMMOCK | 2 - CARABINERS |
| 2 - SHORT FITNESS BAND (YELLOW STRIPE) | 2 - TETHER PIN MOUNTS |
| 2 - MEDIUM FITNESS BANDS (BLUE STRIPE) | 1 - SWIM ACCESSORY BAG |
| 2 - LARGE FITNESS BANDS | |

Step 1:

Unfold the hammock (E) and assemble the header pole located inside of the header pocket at the pillow side (F) of the hammock. Slide the small header pole into the large pole receiver and seal the Velcro flap.

Step 2:

Attach one side of the two Short fitness bands (B) to the mounting rings located at the pillow side of the hammock. Next, attach the other side of the Short fitness bands to Anchor Points (A) located at the lounge side of the spa.

Step 3:

Attach one side of the two Medium fitness bands (C) to the mounting rings located on the foot side of the hammock and the other side to a carabiner (E). Next attach the Carabiner (E) to the Tether Pin (F). Once that assembly is secured, firmly press the Tether pin (F) into the Tether Pin Mounts (G).

Step 4:

Attach one side of the two Large fitness bands (D) to the mounting rings located on the foot side of the hammock. Next attach the other side of the Large fitness bands (D) to the Anchor Points (A) located on the propulsion side of the spa.

Step 5:

Attach Pillow (I) to the hammock (H) by clipping the pillow to the desired location along the pillow attachment strap.

Most users start at the top attachment loop, working their way down, finding the ideal pillow location.

Step 6:

The hammock and associated parts should be removed from the spa after each use and hosed off with regular tap water.

*Always inspect all parts prior to installation, immediately replacing any worn or damaged parts.

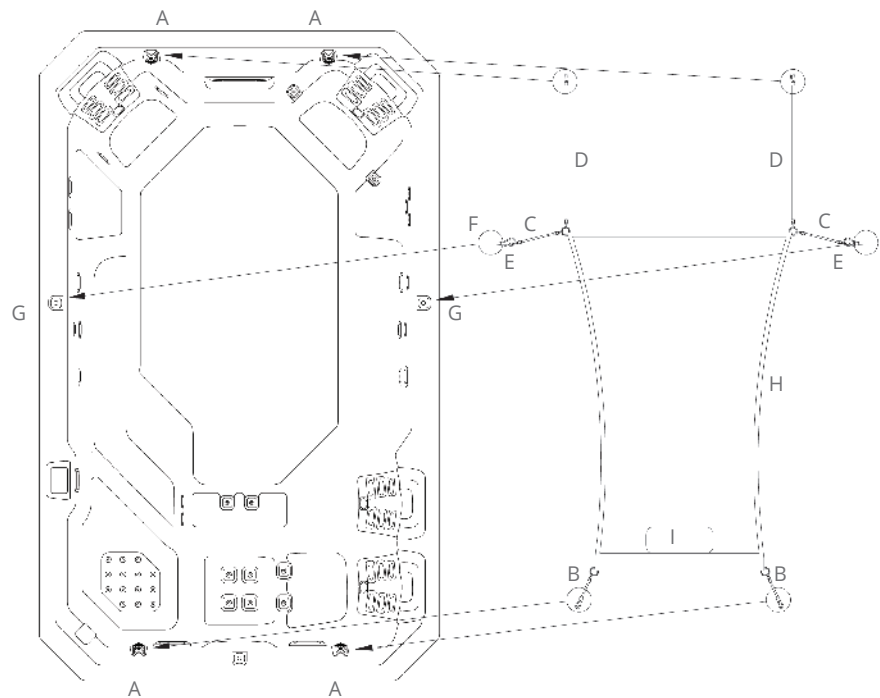

Key

- A. Anchor Point
- B. Short Fitness Band
- C. Medium Fitness Band
- D. Large Fitness Band
- E. Carabiners
- F. Tether Pin
- G. Tether Pin Mount
- H. Hammock
- I. Pillow



INSTRUCTIONS FOR USING YOUR SWIM SERIES™ SWIM TETHER

Swim Tether Kit:

- 1 - SWIMMING TETHER POLE (collapsable into two pieces)
- 1 - FITNESS BAND
- 1 - CARABINER
- 1 - SWIM BELT
- 1 - FITNESS BAND STRAP
- 1 - STRETCH RESISTANCE BAND
- 1 - SWIM ACCESSORY BAG

Step 1:

Connect the tether poles (B) together using the silver metal connector, with the thickest pole on the bottom and the thinner one on top.

Step 2:

Hook the carabiner (C) to the top of the assembled pole.

Step 3:

Connect the resistance band (D) to the carabiner.

Step 4:

Connect the fitness band strap (E) to the resistance band.

Step 5:

Find base plate (A) located on the lounge side middle of the spa. Insert pole securely into the hole of the base plate.

Step 6:

Find the connector on the swim belt (F) and the hook on the end of the strap. Hook the swim belt to the strap and adjust the strap for your preferred length and to optimize swimming capability.

Step 7:

Buckle swim belt around waist and adjust for size.

Step 8:

Begin swimming and enjoy!

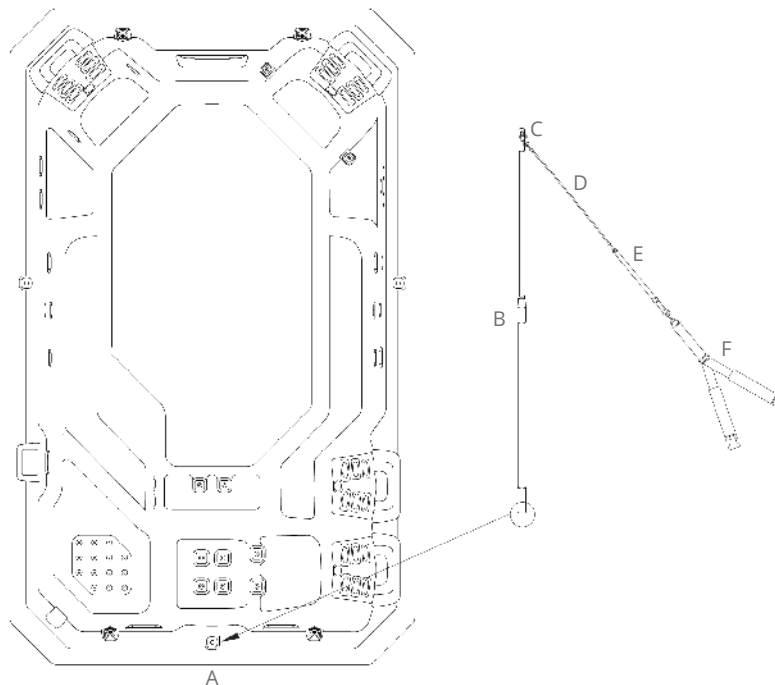

Key

- A. Base Plate
- B. Tether Poles
- C. Carabiner
- D. Resistance Band
- E. Fitness Band
- F. Swim Belt

SWIM
SERIES™

bullfrog
spas

SITE PREP, INSTALLATION, & DELIVERY

Site & Installation Reference

Before attempting to install or use your Swim Series spa, please read Important Safety Instructions as well as all the site preparation tips and installation instructions that follow.

NOTE: Installation of a Swim Series spa in a manner that does not comply with these instructions may void your warranty.

Site Selection and Preparation

Use the information presented in this section to assist you in selecting the best site for your new Swim Series spa. Unlike typical portable spas, these units are not easy to move and are not intended to be moved after installation. Carefully consider where and how you plan to install your Swim Series spa. Although your Authorized Swim Series Dealer may be helpful in evaluating possible installation sites, it is the customer's responsibility to select and prepare your site properly in order to enjoy a smooth, efficient delivery, optimal use, easy service, and full enjoyment of your spa.

Environment

The location in the yard, direction the spa faces, exposure to weather, flatness and slope of the base, and obstacles can all affect your overall experience. Select your spa installation location in consideration of all of these factors. Additionally, consider your lifestyle, privacy preferences, and accessibility. A location near the home is convenient, especially in areas with extreme winter climates. Access to a water source and an area with adequate drainage are must-haves for safely filling and draining your spa. A nearby restroom, with shower, and space for changing clothes can also be convenient.

Outdoor Installation Considerations

It is recommended to install your Swim Series spa outdoors. There are several considerations for outdoor installation and use.

1. Avoid selecting a site where excessive standing water or airborne moisture may contact the spa, such as irrigation, sprinklers, or a roof edge without rain gutters.
2. Avoid areas of direct, prolonged sunlight. Ultraviolet rays can fade or damage exterior surfaces. In particular, avoid areas with strong reflected light from surrounding windows or other reflective surfaces. Reflected light can be especially intense and, over time, is almost always damaging to the exterior surfaces of the spa. Monitor and assess the sunlight conditions at your location well, remembering such conditions change seasonally and throughout the day.
3. Check and ensure adherence to all applicable national, regional, and local codes, laws, and ordinances regarding requirements related to childproof fencing, barriers, and/or

- gates around the spa.
4. Consider methods to prevent dirt, sand, and foliage from being deposited into your spa by utilizing concrete, pavers, and/or stone paths leading to the installation area. Mats can also be helpful for removing debris from feet before entry. It is best to avoid positioning your spa where debris is prevalent. Check the location of trees and spill paths from gutters to determine if wind or rain will sweep debris into or towards your spa.
5. Consider your view and your privacy during all seasons of the year so your experience in your spa will be enhanced rather than limited.

Indoor Installation Considerations

It is not recommended to install Swim Series spas indoors, however, it is possible if specific conditions are met. There are several considerations specific to indoor installations.

NOTE: Swim Series spas are not recommended for indoor environments. However indoor installations are possible if specific requirements are met and the installation location is approved by qualified experts and local regulatory agencies where applicable.

1. Swim Series spas weigh much more than traditional hot tubs. For indoor installations the support structure, both below and around the spa, should be inspected and approved, in advance, by a licensed engineer in accordance with all local codes, laws, and ordinances.
2. Flooring should be water resistant, preferably waterproof, and capable of handling water splashed from the spa, drips likely to occur during filling, draining, cover removal, and should account adequately for the possibility of malfunction.
3. Additional recommendations for water management include, but are not limited to, a floor drain and a catch basin equivalent to the volume of water in your spa.
4. The installation location must be well ventilated. Humidity levels are naturally high with spa use. Excessive humidity and gasses related to spa chemicals can cause damage to floor, wall, and ceiling surfaces, woodwork, and framing, possibly resulting in mildew, dry-rot, or other problems. To minimize the potential for damage, it is best to over-ventilate. Ceiling fans and moisture-resistant paint are recommended. In addition, special ventilation equipment. It is recommended that you consult with a qualified architect and/or ventilation expert for advice.

NOTE: Typical indoor surfaces include, but are not limited to concrete, non-slip tile, or industrial-strength vinyl flooring.

Spa Location Selection

Service access: Should your spa need service, a technician will, in most cases, need to remove the spa's equipment compartment door. Occasionally, additional side panels will also need to be removed. Ensure that your selected installation location provides adequate access to all sides of your Swim Series spa

In-ground installation, decks, or surrounds: Some people choose to install their Swim Series spas partially in the ground or to install stone, landscaping, tile, or custom decking around their spas. While this can allow for easy entry and a custom look, there are considerations that must be evaluated. Most importantly, if you are installing your spa in ground or within a custom surround, remember to always allow access for future service. In addition, it is always best to include a way for the spa to be lifted from the ground or moved without excessive hassle or dismantling of the surrounding structures or landscape. Installers will often leave durable water resistant crane straps in place under the spa, but hidden from sight, for ease of future removal.

Access to Circuit Breakers: For service purposes, allow easy access to the circuit breakers in the electrical service panel.

Electrical Safety Requirements: The installation of all spas must be in accordance with national, regional, and local wiring rules and with applicable permits consistent with local regulations. A licensed electrician must perform the electrical connection and GFCI test procedure. Each Swim Series spa is manufactured and tested to a standard that provides maximum protection against electrical shock.

Improper wiring may prevent the spa from operating safely which could result in electrical shock, injury, or death. Improper wiring could also lead to a malfunction of the spa's equipment and risk of fire. When considering a location for your spa, consult with a licensed electrician pertaining to the following:

Overhead Power Lines: Based upon the national, regional, and local wiring rules that apply to your area, you will need to install your spa at the required minimum horizontal and vertical

distances from all power lines.

Service Disconnect: Based upon your area, a disconnect device must be incorporated into the fixed wiring in accordance with national, regional, and local wiring rules. If the national, regional, and local wiring rules permit, a GFCI or RCD Sub-Panel may be used to substitute the service disconnect, providing that it is located within the same parameters.

Electrical Outlets, Switches and Devices: Based upon the national regional, and local wiring rules that apply to your area, you must install your spa at the required minimum distance from all electrical outlets, switches, and devices.

Bonding: Based upon the national, regional, and local wiring rules, the Control System Box located inside the equipment compartment of your spa must be bonded to all metal equipment, handrails, fixtures, enclosures, pipe, or conduit that are located within the maximum specified distances. The bonding is to be connected to the ground lug connector on the exterior surface of the Control System Box and all metal items previously described.

Equipment Compartment Access: Make sure the spa is positioned so access to the equipment compartment will not be blocked. Ensure compliance with all other national, regional, and local rules that may be applicable.

Water Drainage: Your spa contains an equipment compartment, which houses all of its electrical components. Allowing water into the equipment compartment can damage the electronics, or may result in tripping your spa's circuit breaker. If installing the spa below ground level, or where water may accumulate it is the owner's responsibility to ensure that water will drain adequately so as not to damage spa equipment. For normal installations at ground level choose a site where water will drain away from the spa.

Use of a Cover-Lifting Mechanism: If using a cover-lift, allow up to 18 inches (.61m) of clearance around the spa. Check with your authorized Swim Series Dealer for the exact clearance requirements for the cover-lifting mechanism.

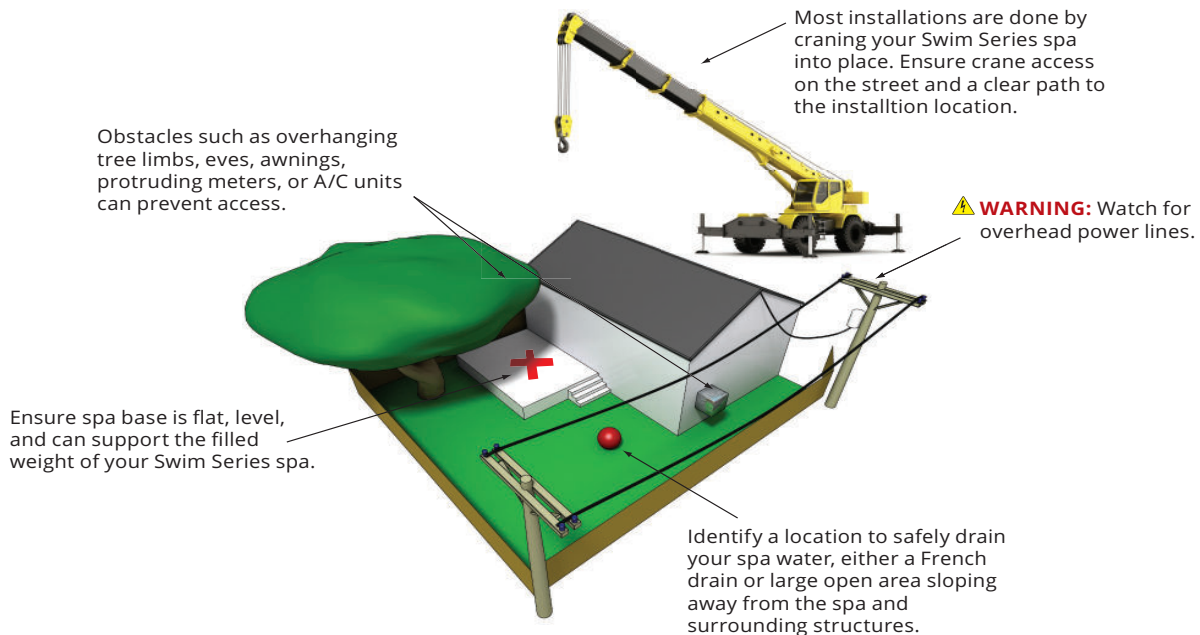

Spa Foundation

General Guidelines: Select a structurally sound flat surface that is reasonably level to serve as your spa's foundation. A foundation that shifts or settles may cause stress to the spa shell.

The foundation that your spa rests on must have a weight bearing load capability of supporting the weight of your spa, its water, and the people using it. The maximum filled weight of a spa can be as much as 20,000 lbs. (9,072kg), plus the weight of the occupants that use the spa (for the weight bearing load requirements as well as the maximum filled weight of your spa, refer to the Swim Series Technical Specifications or contact your local authorized Swim Series Dealer).

If your spa's base is slightly sloped it may not affect the performance of the spa or its structure, however, there should be no dips, sags, or unevenness in the base beneath the spa. Most patios are built to slope away from the house for drainage purposes. There should be no more than a 1/2" (1cm) slope in an 8 ft (2m) run. A concrete pad of adequate thickness to support the filled weight of the spa is recommended for a base. A reinforced deck engineered specifically to exceed the maximum filled weight and adhering to any local, regional, or national building codes that may apply is also a possibility.

NOTE: Concrete bases should be a minimum of 4 inches (10cm) thick and should be reinforced with either rebar or mesh. For electrical grounding purposes, the rebar or mesh should be attached to a bond wire (see Electrical Requirements and Installation Instructions).

WARNING: To prevent serious damage to your spa, it is important that the spa foundation be supported by a flat, stable, and consistent subsurface. Bullfrog Spas highly recommends consulting a qualified, licensed contractor prior to the installation of any spa foundation. For assistance, contact your authorized Swim Series Dealer.

WARNING: Because your spa pad must provide continuous support for the entire base of the spa, you should never level it with shims. If it is necessary to level your spa, make sure the entire spa's structure is fully supported, both in the center as well as the outer edges. When leveling your spa, there should be no voids beneath it. Contact your authorized Swim Series Dealer before making any leveling adjustments. Structural damage to the spa resulting from incorrect installation, placement on an inadequate foundation, or improper leveling will void the spa's

warranty.

Elevated Installations: Be certain your deck or elevated structure can support the maximum filled weight of your spa with the total weight of occupants that use it. You must know the deck's weight-bearing load capacity and ensure that it is greater than the maximum filled weight of your spa combined with the occupants using it or serious injury or structural damage could result.

To find the weight bearing load requirement along with the maximum filled weight of your spa, refer to the Spa Technical Specifications or contact an authorized Swim Series Dealer.

Concrete Pad

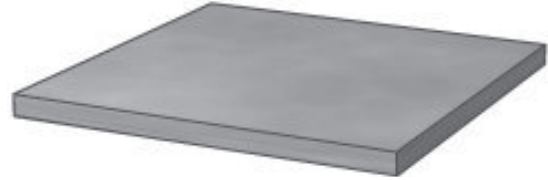

CAUTION: Consult a qualified structural engineer or contractor before the spa is placed on an elevated structure or deck.

Design Considerations

Hard-Surface Options (Decking and Flooring):

In addition to selecting a hard surface that meets the recommended safety and maintenance criteria, consider textures and colors that will assist in enhancing the aesthetics of the area in which your spa will be installed. The decision to match, contrast, or blend the hard surface colors and textures with those of your spa can accentuate your spa experience. The cost of a landscape architect or designer may be money well spent.

Surrounding Landscape: The correct landscape around your spa will not only soften the adjacent hard surface areas, but will add life and much enjoyment to the environment. If the budget allows, you may want to consult with a landscape architect or designer for expert advice.

Spa-Side Accessories: Besides selecting the correct hard surfaces and landscape around your spa, the addition of the proper spa-side accessories will provide just the finishing touch that you are looking for. Spa steps, benches, towel racks, planter boxes, or an outdoor fireplace are just a few of the items that can be considered when accessorizing your spa.

Delivery Basics

To prepare for the delivery of your spa, make sure the delivery path is clear and no obstructions are present.

In most cases, due to the dimensions and weight, a crane will be required to install your Swim Series spa by lifting it to its final installation location. A qualified crane operator can lift your spa over walls, buildings, or any other obstruction and place your spa directly at or as close to the installation site as possible. Be sure to evaluate your installation to ensure crane access is possible.

In rare cases with ample, safe vehicle and trailer access to the spa installation site, your spa may be offloaded directly and/or dollyed or moved on rollers a short distance into place.

WARNING: An empty spa (spa without water in it) must not be left exposed to sunlight as shell damage may occur. Once the spa is unwrapped, fill spa with water immediately or shade the spa with cover or wrapping to prevent direct exposure to sunlight.

WARNING: Watch for power lines.

Spa Dimensions Chart

Model	Width	Length	Height	Weight (dry)
S150	94" (2.39m)	152" (3.86m)	52" (1.32m)	2,000 lbs* (907 kg)
S180	94" (2.39m)	180" (4.57m)	52" (1.32m)	2,344 lbs.* (1,063 kg)
S180XD	94" (2.39m)	180" (4.57m)	60" (1.52m)	2,532 lbs.* (1,148 kg)
S200	94" (2.39m)	205" (5.20m)	52" (1.32m)	2,500 lbs* (1,134 kg)

Corner flat is 12" (0.305m) at a 45 degree angle.

*Approximate. Actual dry weight TBD.

Electrical Requirements & Installation Instructions

IMPORTANT: Provide a copy of these instructions to your Electrician. The installation of all spas must be in accordance with national and local wiring rules. Always have a licensed electrician perform the electrical installation. Each Swim Series spa is manufactured and tested to a standard that provides maximum protection against electrical shock. Improper wiring may prevent the spa from operating safely which could result in electrical shock, injury or death. Improper wiring could also lead to a malfunction of the spa's equipment and risk of fire.

Drilling Conduit Hole:

All dimensions are at the bottom base.

1" (2.54cm) Conduit Drill 1-3/8" (3.49cm) hole 3/4" (1.91cm) Conduit Drill 1-1/8" (2.86cm) hole Center of hole is 1" (2.54cm) from the ground

Important Technical Information

Voltage Definitions: When reading these instructions, the term 240V~ term refers to the 220-240 range of voltage.

Wiring Connection: Appliance must be permanently connected to fixed wiring.

Wiring Diagrams: In addition to the instructions that follow, please reference the appropriate Wiring Diagrams 240V~/60Hz Permanently-Connected, or 230V~/50Hz Permanently-Connected).

Electrical Service Wire Size and Type: The size of wire required to supply the spa with power is dependent upon the length of the electrical run and should only be determined by a licensed electrician. Installation must be in accordance with all national, regional, and local wiring rules. **All wiring from the disconnect to the spa must be copper to ensure adequate connections. Never use aluminum wiring from the GFCI disconnect to the spa"**

Location Electrical Considerations

Overhead Power Lines: Based upon the national and local wiring rules that apply to your area, you will need to install your spa at the required minimum horizontal and vertical distances from all power lines. The presence of overhead power lines may also obstruct and, in rare cases, prohibit the installation of your Swim Series spa.

Service Disconnect: Based upon your area, a disconnect device must be incorporated into the fixed wiring in accordance with national, regional, and local wiring rules. If the national, regional, and local wiring rules permit, a GFCI Sub Panel may be used to substitute the service disconnect, providing that it is located within the same parameters.

Electrical Outlets, Switches and Devices: Based upon the national, regional, and local wiring rules that apply to your area, you must install your spa at or beyond the required minimum distance from all electrical outlets, switches, and devices.

Bonding: Based upon the national, regional, and local wiring rules that apply to your area, the Control System Box located inside the equipment compartment of your spa must be bonded to all metal equipment, handrails, fixtures, enclosures, pipe, or conduit that are located within the maximum specified distances. The bonding is to be connected to the ground lug connector on the exterior surface of the Control System Box and all metal items previously described.

Equipment Compartment Access: Make sure the spa is positioned so that access to the equipment compartment will not be blocked.

Ground Fault Circuit Interrupters (GFCI) or

Residual Current Devices (RCD): As per national, regional, and local wiring rules, all spas, hot tubs, and associated electrical components must be protected by a GFCI or RCD, either at the main breaker box or at the service disconnect.

WARNING: Removal or bypassing the GFCI will result in an unsafe spa and will void your spa's warranty. When installing the GFCI, all conductors except the green ground must be routed through the GFCI, including the neutral. Never bypass the neutral line. If the neutral line is bypassed, then the current will be imbalanced and cause the GFCI to trip. See GFCI Wiring Diagrams or contact your Authorized Swim Series Dealer.

REQUIRED TEST PROCEDURE: After the spa is first filled and turned on, and prior to each use, the GFCI should be tested as follows:

Step 1: Press test on the GFCI breaker. The spa should stop operating.

Step 2: After 30 seconds, press reset and then verify that power has been restored to the spa. If the GFCI fails to operate in this manner you may have an electrical malfunction and be at risk of electrical shock. Should this occur, turn off the GFCI breaker to the spa and do not use the spa until the malfunction has been repaired by a licensed electrician or your authorized Swim Series Dealer.

Dedicated Electrical Circuit Breaker: The electrical service to the spa must include a suitably rated switch or circuit breaker. Whether the spa is a 240V~/60Hz or 230V~/50Hz Permanently-Connected spa, it is required that the circuit breaker that supplies power to the spa is dedicated and does not supply power to any other electrical outlet, device or item.

Electrical Access Conduit: Each Swim Series spa is manufactured with electrical access chaseways in its base to allow conduit to be run to the spas control system. These chaseways are marked by stickers indicating access points.

12V Maximum on Live Parts: Live parts accessible to the user must not exceed 12V.

New Installations and Re-Installations

These instructions apply to both new installations and re-installations which may occur when a spa is moved or relocated to a new location. It is not recommended to move your Swim Series spa after installation and doing so made void your warranty. However, in the case that this becomes necessary, use the following procedures and follow the recommendations of your Authorized Swim Series Dealer.

240V~/60Hz Equipment

Permanently-Connected 240V~/60Hz spas require a GFCI protected, 4-wire (Line 1, Line 2, Neutral, and Ground), 240V~/60Hz, 50A, Single-Phase, dedicated electrical circuit. It is important that this circuit is dedicated (not being used by any other electrical appliance) or the spa may not function properly. Spa models with 3 jet pumps (S180, S180XD, S200) require a 50A service for full functionality. Installation must be in accordance with all national and local wiring rules

230V~/50Hz Equipment (Europe)

This equipment allows for the spas to operate only on a 230V~/50 Hz electrical service.

Permanently-Connected 230V~/50Hz, 32A spas require an RCD protected, 230V~50Hz, 32A Single-Service, or 16A Single Service, or 16A-16A x2, 400V~,3N, 50Hz, 16Ax3, dedicated electrical circuit. It is important that this circuit is dedicated (not being used by any other electrical appliance) or the spa may not function properly. For specific conversion instruction, please refer to the system wiring diagram inside the Control System Box (located in the spa's equipment compartment). Installation must be in accordance with all national and local wiring rules.

Connecting the Electrical Service

IMPORTANT: Installation must be in accordance with all national and local wiring rules and performed by a licensed Electrician.

Step 1: Choose one of the available conduit entry points. (indicated by decal on the spa base)

Step 2: Determine the conduit diameter and drill a hole that is properly sized for the conduit ($\frac{3}{4}$ " conduit drill 1-1/8" hole, 1" conduit drill 1-3/8" hole).

Step 3: Push the conduit through the hole until it comes out into the equipment area

Step 4: Remove the faceplate to the Control System Box

Step 5: Connect the conduit to the Control System Box using a Liquid Tight Connector.

Step 6: Run the required wires through the conduit to the Control System Box.

Step 7: Connect the electrical service wires to the terminal block located in the Control System Box.

Step 8: Replace the Control System Box faceplate and the equipment compartment door. The electrical hook-up is complete.

Note: To conform with electrical codes, and to create a barrier against pests, any holes created in the base of your Bullfrog Spa should be fitted with an appropriate connector.

This guide will assist in solving simple problems with the spa. If the problem cannot be solved using these procedures, contact your authorized Bullfrog Spas Dealer.

Control panel displays an error message:

Cause: An error has occurred.

Solution: See Diagnostic Messages for specific errors.

Control pad and spa equipment do not operate:

Cause #1: No electrical power to spa.

Solution: Turn on or reset the GFCI circuit breaker. If this does not solve the problem, have a qualified Electrician check the electrical service.

Cause #2: The 20 or 30A fuse, depending on the system, has blown.

Solution: Contact your authorized Bullfrog Spas Dealer.

GFCI breaker trips repeatedly:

Cause #1: Improper wiring to spa or GFCI breaker is defective.

HARDWARE SETUP & WIRING

(North America 60 Hz)

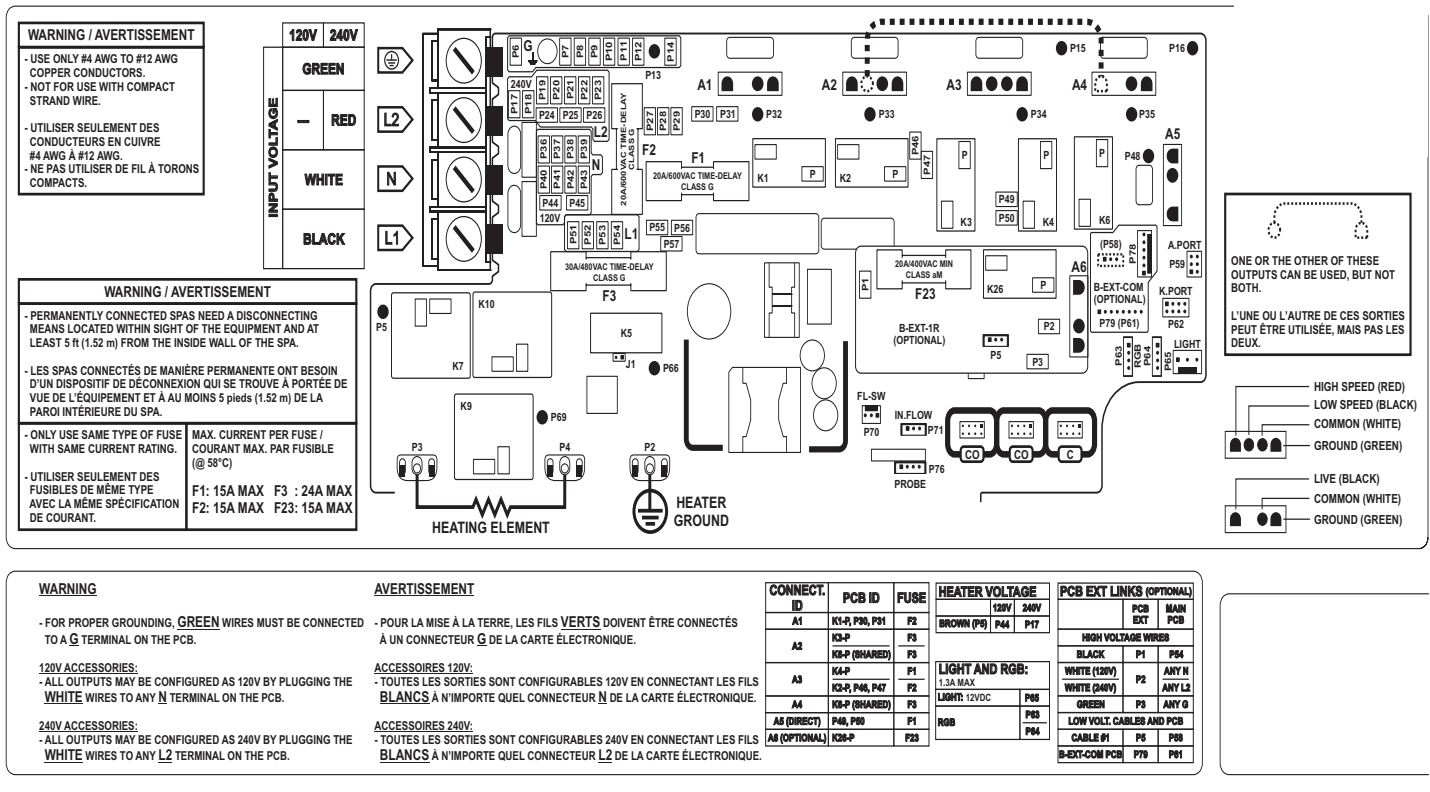

WARNING

- FOR PROPER GROUNDING, **GREEN** WIRES MUST BE CONNECTED TO A **G** TERMINAL ON THE PCB.

120V ACCESSORIES:

- ALL OUTPUTS MAY BE CONFIGURED AS 120V BY PLUGGING THE **WHITE** WIRES TO ANY **N** TERMINAL ON THE PCB.

240V ACCESSORIES:

- ALL OUTPUTS MAY BE CONFIGURED AS 240V BY PLUGGING THE **WHITE** WIRES TO ANY **L2** TERMINAL ON THE PCB.

AVERTISSEMENT

- POUR LA MISE À LA TERRE, LES FILS **VERTS** DOIVENT ÊTRE CONNECTÉS À UN CONNECTEUR **G** DE LA CARTE ÉLECTRONIQUE.

ACCESSOIRES 120V:

- TOUTES LES SORTIES SONT CONFIGURABLES 120V EN CONNECTANT LES FILS **BLANCS** À N'IMPORTE QUEL CONNECTEUR **N** DE LA CARTE ÉLECTRONIQUE.

ACCESSOIRES 240V:

- TOUTES LES SORTIES SONT CONFIGURABLES 240V EN CONNECTANT LES FILS **BLANCS** À N'IMPORTE QUEL CONNECTEUR **L2** DE LA CARTE ÉLECTRONIQUE.

CONNECT. ID	PCB ID	FUSE	HEATER VOLTAGE	
			120V	240V
A1	K1-R, P30, P31	F2	BROWN (P6)	P44 P17
A2	K3-P	F3		
	K3-P (SHARED)	F3		
A3	K4-P	F1		
	K2-R, P46, P47	F2		
A4	K3-P (SHARED)	F3		
A5 (DIRECT)	P48, P50	F1		
A5 (OPTIONAL)	K26-P	F23		

LIGHT AND RGB:	
1.3A MAX	
LIGHT: 12VDC	P65
RGB	P63 P64

PCB EXT LINKS (OPTIONAL)		
PCB EXT	MAIN PCB	
HIGH VOLTAGE WIRES		
BLACK	P1	P64
WHITE (120V)	P2	ANY N
WHITE (240V)	P2	ANY L2
GREEN	P3	ANY G
LOW VOLT. CABLES AND PCB		
CABLE #1	P8	P88
B-EXT-COM PCB	P79	P81

NOTE: Spa models with 3 jet pumps (S200) require a 50A service for full functionality. Installation must be in accordance with all national and local wiring rules. These models may alternatively be operated with various electrical configurations, however, certain set ups may result in operation limitations.

ELECTRICAL CHASEWAYS & STUB-UP LOCATIONS

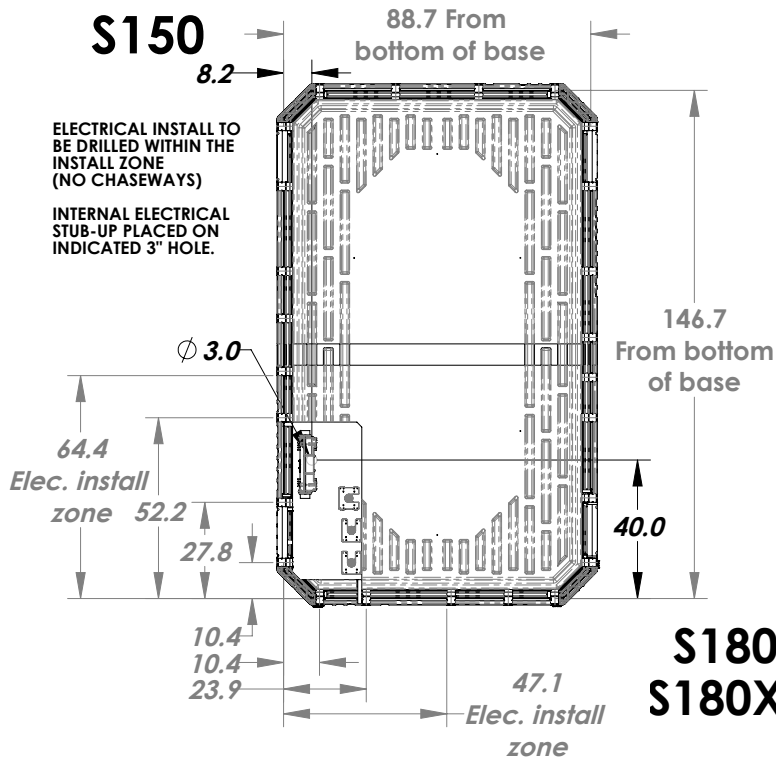

**S180
S180XD**

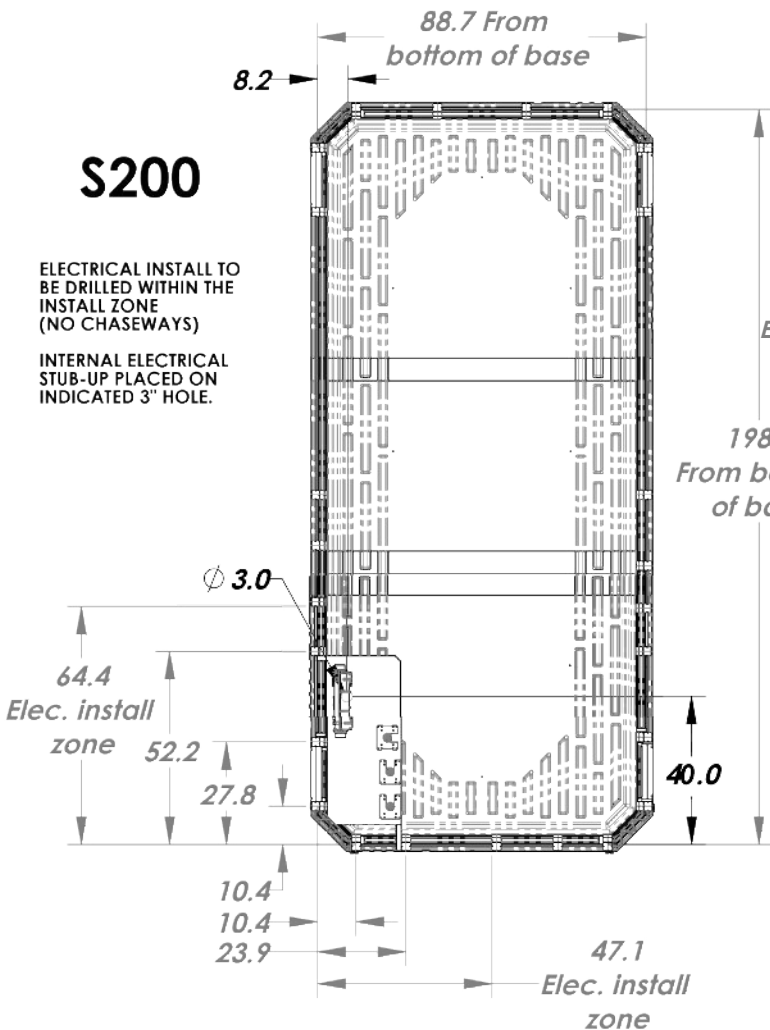
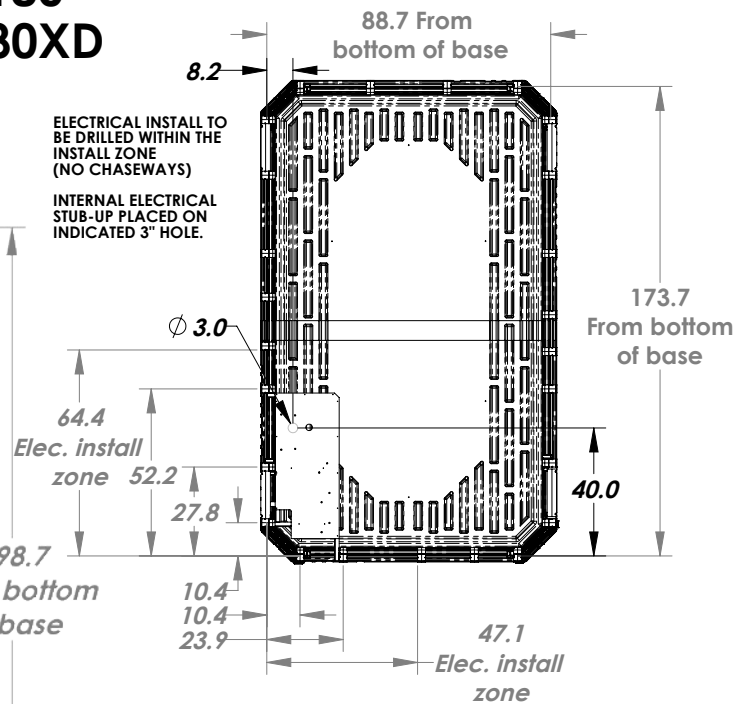

GFCI WIRING

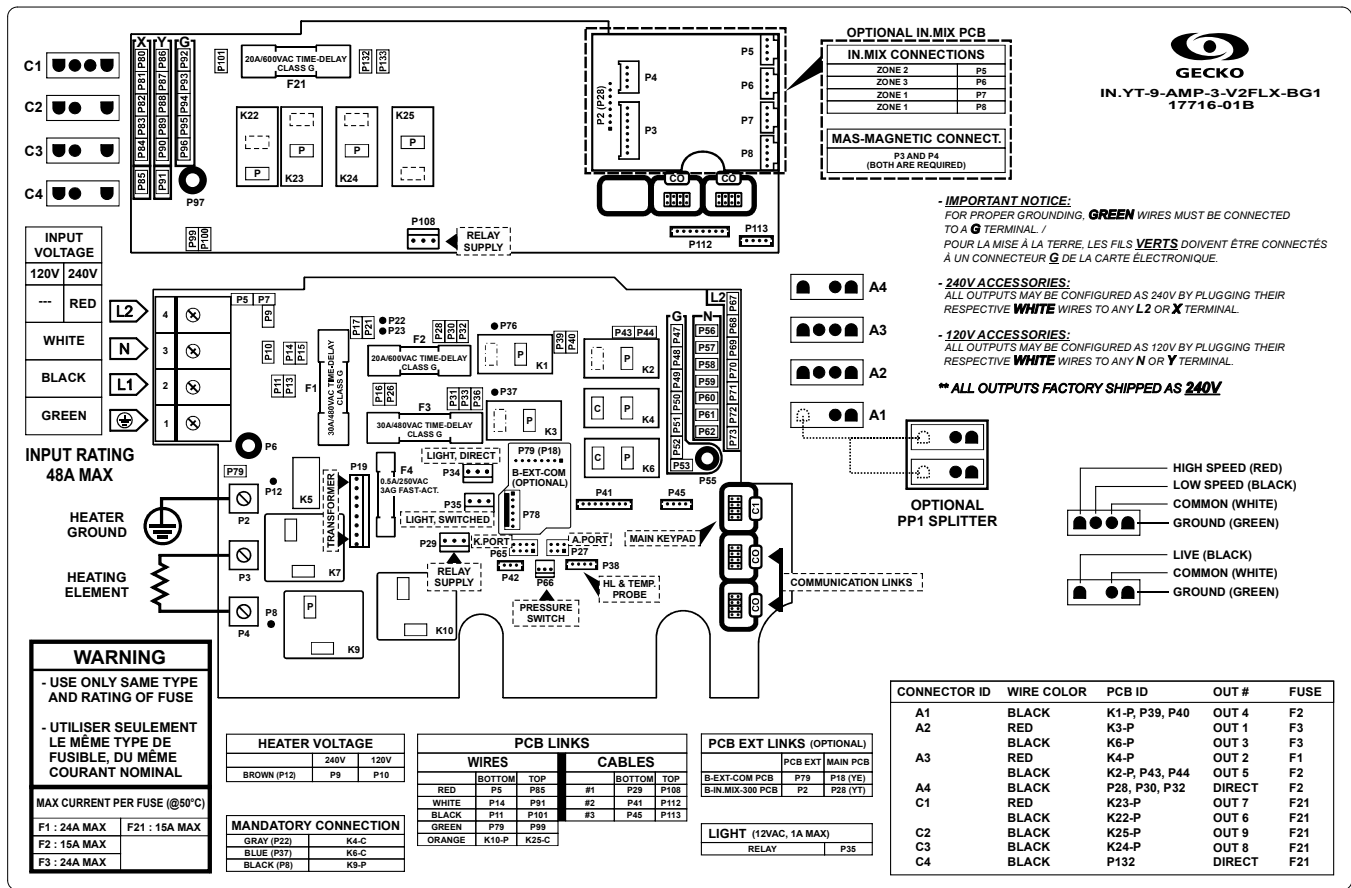

Insert each wire into the appropriate socket of the main entry terminal block according to the color code indicated on the sticker. Use a flat-head screwdriver to tighten the screws on the terminal.

After making sure wires are securely connected, push them back into the box and replace the cover. Do not over tighten cover screws (torque to 8 in. lb max {0.9 N.m}).

Connect the bonding conductor to the bonding lug on the front of the spa pack (a grounded electrode conductor should be used to connect the equipment grounding conductors).

NOTE: On initial connection the installer is prompted for electrical configurations. The Low-Level setting is selected by the installer. The Phase and Amperage is set automatically. Default settings should be confirmed by the installer to match the actual phase and amperage at the spa's installation location. In rare occasions it may be necessary to adjust the Phase and Amperage setting to match the actual service available at the installation location using the Electrical Configuration instructions for your spa's specific control system. The "Input Amperage" for a 60A service is 48. The "Input Amperage" for a 50A service is 40.

DISPLAY MESSAGES & ERROR MESSAGES

Code	Message
HL	High Limit circuit has tripped!
FLO - L01 FLO - L02 FLO	FLO condition - Check filter, pump, blockage, air lock and water level
NO FLO	Persistent NO FLO, all off - Check filter, pump, blockage, air lock and water level
HR	A hardware error was detected (Relay stuck)
OH	Spa temperature is too high
Pr	Temp probes or detection circuit are defective
AOH	Elevated internal temperature
FLC	The pressure switch is closed
SP in	Input voltage issue
RH NC	Comm. error between in.xm2 - in.therm
RH ID	in.xm2 and in.therm incompatible
SC ER	Error detected during the learning mode
F1	in.xm2 Fuse # 1 is blown
F2	in.xm2 Fuse # 2 is blown
F3	in.xm2 Fuse # 3 is blown
ER1	SwimSpa config. : slave unit is missing
Hr	Hardware error was detected (Thermal fuse)
UPL	The spa pack does not have valid software. Please insert valid in.stick to reprogram spa pack.
CFLO	No Flow condition
HIBr	Add fresh water to the spa
HiBr	Add fresh water to the spa
LoBr	Add BromiCharge to spa water
NoBr	Add BromiCharge to spa water
Comm	Verify cable connections
Supp	Connect power cord to 240 V source

TROUBLESHOOTING GUIDE

Solution: Consult with a qualified Electrician.

Cause #2: There is a defective component on the spa.

Solution: Contact your authorized Bullfrog Spas Dealer.

Spa pump turns off during operation:

Cause #1: Automatic timer has completed its 30 or 60 minute cycle.

Solution: Turn on the pump.

Cause #2: Pump has overheated due to the vents on the equipment door being blocked.

Solution: Clear items away from vents.

Cause #3: The pump motor is defective.

Solution: Contact your authorized Bullfrog Spas Dealer.

Spa will not heat:

Cause #1: Thermostat has been turned down or set to low heat range.

Solution: Adjust thermostat to desired temperature or set to high heat range.

Cause #2: High limit sensor has tripped.

Solution: Press any button to reset.

Cause #3: Heating system is defective.

Solution: Contact your authorized Bullfrog Spas Dealer.

LED Spa lights do not work:

Cause #1: A light bulb has burned out.

Solution: Replace light bulb.

Cause #2: Lighting system is defective.

Solution: Contact your authorized Bullfrog Spas Dealer.

Jets surge on and off:

Cause: Water level is too low or filters may be dirty.

Solution: Adjust water to the water level indication mark on the faceplate of the filter assembly. Clean the filters.

Spa pump will not turn on, creates a burning smell while running, or makes excessive noise while running:

Cause: Pump motor is defective. Running during high ambient outside temperatures, excessive run time.

Solution: Contact your authorized Bullfrog Spas Dealer.

Jets are weaker than normal or do not work at all, but the pump is running:

Cause #1: Jets body valves are partially or fully closed or JetPak valves are partially or fully closed.

Solution: Open jet valve(s).

Cause #2: Filter cartridge is dirty.

Solution: See Cleaning the Filter.

Cause #3: There is air trapped in the spa equipment or its face piping.

Solution: Remove the clamp to the air bleed line and remove the air line from the pump until air has purged out and you see water flow and reconnect.

Cause #4: The suction fitting(s) are blocked.

Solution: Remove any debris that may be blocking the suction fitting(s).

LIMITED WARRANTY

Swim Series

Bullfrog International, LC (“Bullfrog”) extends warranty coverage solely to the original retail purchaser or end-user (“Owner”) of any Swim Series spa manufactured by Bullfrog on or after January, 2022 for 2022 and later models at the original location where first installed for residential use in the United States or Canada. Warranty coverage period begins at the earlier of time of original retail purchase or 1-year after original manufacture date.

Lifetime Warranty

EnduraFrame™

- Bullfrog warrants the EnduraFrame (injection-molded spa support structure) against degradation for the life of the original retail purchaser of the spa.

10-Year Warranty

Shell Structure

- Bullfrog warrants the Bullfrog Spa shell not to leak for ten years from the original retail purchase date.

7-Year Warranty

Shell Surface

- Bullfrog warrants the surface finish of the Bullfrog Spa not to crack, blister, peel or delaminate for seven years from the original spa purchase date.

3-Year Warranty

Patio Performance™ Spa Cover

- Bullfrog warrants the Patio Performance spa cover against defects in materials or workmanship not determined to be regular fading or wear for 3 years from the original spa purchase date.

1-Year Warranty

Lighting Systems

- Bullfrog warrants the Interior and Exterior Spa Lighting Systems against defects in materials and workmanship for one year from the original spa purchase date. Defective components that are easily removed from the spa, such as the exterior LED bulb (including sconce), which are deemed Easily Removed Components, will be repaired or replaced free of charge at your authorized Bullfrog Spa Dealer or by sending the defective component(s) to Bullfrog.

Audio Systems

- Bullfrog warrants audio systems against defects in materials and workmanship for one year from the original spa purchase date.

Water Care Systems

- Bullfrog warrants mechanical water care systems, including those using ozone, UV, or other similar technologies, against defects in materials and workmanship for one year from the original spa purchase date.

5-Year Warranty

Equipment

- Bullfrog warrants electrical and mechanical equipment against malfunction or failure for five years from the original retail purchase date.
- Warranty specifically covers pump(s), heater, control system (including fuses), other mechanical equipment, and leaks from any component or fitting located beneath the spa shell.
- Electrical and mechanical equipment with its associated piping and fittings warranted against defects in materials and workmanship for five years from purchase date.
- Defective components that are easy to remove and that can be readily replaced by the customer and do not require specialized tools or knowledge or create personal safety issues, all of which are deemed Easily Removed Components, will be repaired or replaced free of charge by your authorized Bullfrog Spa Dealer or by sending the defective component(s) to Bullfrog for exchange. This warranty excludes audio systems, water care systems, and the interior and exterior spa lighting systems.

Spa Cabinet & Base

- Cabinet sections (corners, doors, side panels) are warranted against degradation and cracking, not including normal weathering, fading, or expansion, for five years from purchase date.
- Warranty specifically covers the cabinet corners, door and side panels, and the molded spa base.
- EnduraBase™ is warranted against degradation and cracking for five years from purchase date. Defective items will be repaired under the terms of this warranty.

JetPak Therapy System®

- JetPak Therapy System® (JetPaks and associated mechanical systems) warranted for five years from purchase date.
- Warranty specifically covers the jets, any leaks from JetPak jet fittings, and all JetPak plumbing.
- Color availability on replacement and aftermarket JetPaks is guaranteed for one year.

Other Warranties

- Bullfrog warrants the Swim Series pillows, jet faces, accessory anchors, skimmers, seat and floor coverings, and filter(s) against defects in materials and workmanship through time of delivery.

Warranty Performance

Bullfrog or its authorized agent will repair or replace any malfunctioning or defective component on the Swim Series spa that is covered under the terms of this limited warranty and was purchased from an authorized Swim Series spa dealer. In doing so, Bullfrog reserves the right, at its option, to either repair or replace the defective component.

As Swim Series spas are large and often require complex and/or expensive installation methods and accommodations, all reasonable efforts will be made to repair or replace components on site where the Swim Series spa is installed. If Bullfrog or its authorized agent determines that onsite repair of the defect or replacement of components is not feasible due to limitations created by the nature of the spa installation location, we reserve the right to request removal of the spa from its installation location to ensure safe technician access. In such an event, costs for moving the spa to a workable location and reinstallation of the product after repairs will be the sole responsibility of the owner. In the rare case that a replacement spa is required to adequately address the defect or malfunction, removal costs, shipping costs of the replacement product, and delivery costs to the installation location will be the sole responsibility of the owner.

Bullfrog reserves the right to use either new or reconditioned replacement components. In some situations, the servicing dealer may charge the owner a reasonable travel mileage fee. Any repair or replacement shall provide no new warranty coverage, but shall retain only the remaining portion of the original product's warranty.

Bullfrog's Lifetime warranties provide coverage solely to the original retail purchaser of the spa and extend only for the length of his or her lifetime. If the original retail purchaser is not a natural person (i.e. Corporation, L.L.C., Family Trust, etc.), "life of the purchaser" shall mean ten years.

To obtain warranty service, contact your authorized Swim Series dealer or Bullfrog and submit proof of purchase. Any defective removeable component sent directly to the factory for warranty repair must be pre-authorized by Bullfrog and must be freight prepaid. Return freight will be paid by Bullfrog on all warranted components.

Repair or replacement, as described above, shall be Bullfrog's sole liability for any breach of this limited warranty.

Exclusions

This Swim Series spa limited warranty is void if any of the following occur:

- The spa has been subject to alteration, neglect, misuse or abuse.
- Any repairs are attempted by anyone other than an authorized agent of Bullfrog.
- The spa has been used in a non-residential application or in an application for which it was not designed.
- Damage is caused by an Act of God or any other cause beyond the control of Bullfrog.
- Damage is caused by the addition or use of any non-approved mechanical or electrical component, or chemical substance.
- The spa has been moved from original installation location.
- Damage is caused by shipping, moving, mishandling, improper installation or electrical hook-up by someone other than Bullfrog or authorized agent.
- Damage to the spa shell is caused by excessive heat build-

up due to failure to cover spa while empty of water and/or exposed to direct sunlight.

- Damage is caused by operating the spa outside the water temperature range of 32°F-120°F (0°C-49°C).
- Damage to shell surface (micro-crazing) or to other equipment or components, which is caused by improper maintenance of spa water chemistry, including misuse of chemical sanitizers, allowing undissolved spa chemicals to lie on the spa's surface, or any other use of chemicals not approved or recommended by Bullfrog or its authorized agent.
- Damage is caused by failure to install, maintain and operate the spa in accordance with the recommendations contained in the Swim Series Owner's Manual or any other official printed or digitally published instructions, notice or bulletin from Bullfrog.

Limitations

THIS LIMITED WARRANTY TAKES THE PLACE OF ALL OTHER WARRANTIES, EXPRESS OR IMPLIED, IN FACT OR AT LAW, INCLUDING IMPLIED WARRANTIES OF MERCHANTABILITY AND FITNESS FOR A PARTICULAR PURPOSE. ALL WARRANTY SERVICE MUST BE PERFORMED BY BULLFROG OR ITS AUTHORIZED AGENT. NO AGENT, DEALER, DISTRIBUTOR, SERVICE COMPANY OR OTHER PARTY IS AUTHORIZED TO CHANGE, MODIFY OR EXTEND THE TERMS OF THIS LIMITED WARRANTY IN ANY MANNER WHATSOEVER.

Disclaimers

BULLFROG AND ITS AUTHORIZED AGENTS SHALL NOT BE LIABLE FOR ANY INJURY, LOSS, COST OR OTHER DAMAGE, WHETHER INCIDENTAL, CONSEQUENTIAL, SPECIAL OR PUNITIVE, ARISING OUT OF ANY DEFECT COVERED BY THIS LIMITED WARRANTY, INCLUDING WITHOUT LIMITATION, LOSS OF USE OF THE SPA AND COST FOR REMOVAL OF DEFECTIVE PRODUCT, EVEN IF BULLFROG HAS BEEN ADVISED OF THE POSSIBILITY OF SUCH DAMAGE. THE LIABILITY OF BULLFROG UNDER THIS LIMITED WARRANTY, IF ANY, SHALL NOT EXCEED THE ORIGINAL AMOUNT PAID FOR THE DEFECTIVE PRODUCT. COVERAGE UNDER THIS LIMITED WARRANTY SHALL COMMENCE AS OF THE ORIGINAL DATE OF PURCHASE AND THE DURATION OF SUCH COVERAGE SHALL NOT EXTEND FOR ANY REASON WHATSOEVER BEYOND THE STATED TIME PERIOD. THESE DISCLAIMERS SHALL BE EQUALLY APPLICABLE TO ANY SERVICE PROVIDED BY BULLFROG OR ITS AUTHORIZED AGENTS.

Legal Rights

This Limited Warranty gives you specific legal rights. You may also have other rights which vary from state to state. Some states do not allow limitations on how long an implied warranty lasts, so this limitation may not apply to you. Prompt registration of your warranty helps protect your warranty rights.

Updated 2/2022

U.S. Patents: 5,754,989, 5,987,663, 6000,073, 6,092,246, 6,256,805, 6,543,067.

Additional patents pending.

New Zealand Patent: 334,093.

Canada Patent: 2,260,237

Other patents pending: 12 additional countries.

7017 West 11800 South • Herriman, Utah 84096
Tel (801) 565-8111 • Fax (801) 565-8333
www.bullfrogspas.com • info@bullfrogspas.com



Bullfrog International, LC
668 W. 14600 S.
Bluffdale, UT 84065
T: 801.565.8111
F: 801.565.8333
E: info@bullfrogspas.com

v 2.5

Register your spa online by visiting:
bullfrogspas.com/warranty-registration

North America 2024
Bullfrog International LC