

# QUICK REFERENCE

To assist you with the installation and maintenance service of your new spa, please fill out the following information and keep it on hand for future reference.

## **Spa Information**

Spa \_\_\_\_\_  
Model: \_\_\_\_\_  
Serial Number: \_\_\_\_\_  
Dealership: \_\_\_\_\_  
Dealer's Phone Number: \_\_\_\_\_  
Date Purchased: \_\_\_\_\_  
Date Installed: \_\_\_\_\_

## **Contractor Information**

### **General**

1. Name: \_\_\_\_\_  
Telephone: \_\_\_\_\_  
2. Name: \_\_\_\_\_  
Telephone: \_\_\_\_\_

## **Electrician**

1. Name: \_\_\_\_\_  
Telephone: \_\_\_\_\_  
2. Name: \_\_\_\_\_  
Telephone: \_\_\_\_\_

## **Concrete, Decking, and Masonry**

1. Name: \_\_\_\_\_  
Telephone: \_\_\_\_\_  
2. Name: \_\_\_\_\_  
Telephone: \_\_\_\_\_

## **Landscaping**

1. Name: \_\_\_\_\_  
Telephone: \_\_\_\_\_  
2. Name: \_\_\_\_\_  
Telephone: \_\_\_\_\_



# **TABLE OF CONTENTS**

<b>Quick Reference:</b>	<b>1</b>
<b>Table of Contents:</b>	<b>2</b>
<b>Important Overview:</b>	<b>3</b>
<b>Safety Instructions:</b>	<b>4</b>
<b>Getting to Know Your Spa:</b>	<b>7</b>
<b>Equipment Compartment:</b>	<b>9</b>
<b>Filling Your Spa:</b>	<b>10</b>
<b>STIL/A Series Touch Control Panels:</b>	<b>11</b>
<b>A Series Spas (A900) Control Panels:</b>	<b>15</b>
<b>R Series Spas (R600) Control Panels:</b>	<b>21</b>
<b>X Series Spas Control Panels:</b>	<b>25</b>
<b>Jetpaks and Jets:</b>	<b>27</b>
<b>Water Care and Chemistry:</b>	<b>28</b>
<b>Spa Maintenance:</b>	<b>30</b>
<b>GFCI Wiring Diagrams:</b>	<b>42</b>
<b>Display and Error Messages:</b>	<b>48</b>
<b>Troubleshooting Guide:</b>	<b>55</b>
<b>Limited Warranty:</b>	<b>56</b>

# IMPORTANT OVERVIEW



Congratulations on your purchase of a Bullfrog Spas A Series, R Series, STIL, or X Series hot tub†.

**NOTE:** In this document, the terms “Spa” and “Hot Tub” are used interchangeably. Take a moment to read this manual carefully as you set up and use your new spa. Following the instructions in this manual will ensure the safe, secure, and timely installation and operation of your new spa.

Carefully read this Owner’s Manual before you install your spa. Your Bullfrog Spa Limited Warranty will be void if damage is caused by failure to install, maintain, and operate your spa in accordance with the recommendations contained in this Owner’s Manual or any other printed instruction, notice or bulletin from Bullfrog Spas. Your spa’s serial number is located both on the base under the equipment door and the Manufacturing ID Label located inside the equipment compartment of your spa.

For the safety of all those who utilize your spa and its surroundings, please make sure your spa and any adjoining installations, including the electrical hook-up, are completed only after acquiring any necessary approvals and permits from your local city and/or county. Follow all local and national safety and wiring rules. Some jurisdictions require certain fencing and/or self-closing and self-latching gates to prevent accidental drowning in a pool or spa. Your spa cover comes with a locking system that meets the ASTM F1346-91 Standard for Safety Covers, which when properly used, may satisfy certain fencing and gating requirements. Your spa meets or exceeds all requirements of the Virginia Graeme Baker Pool and Spa Safety Act. Your spa has been tested and either meets or exceeds the UL-1563 portable spa standard.



C € IPX5

**U.S. Patents:** 7,908,684, 8,661,576, 8,881,321, 8,689,370, 8,869,469, 5,754,989, 5,987,663, 6,000,073, 6,092,246, 6,256,805, 6,543,067.

**New Zealand Patent:** 555112, 334,093

**Australia Patent:** 737,335

**Canada Patents:** 2,588,884, 2,260,237,

**Other patents pending worldwide**

† Bullfrog Spas are available in four different series that include the following models:

**A Series:** A8, A8L, A8D, A7, A7L, A6L, & A5L

**R Series:** R8, R8L, R7, R7L, R6L & R5L

**STIL:** S7L

**X-Series:** X8, X8L, X7, X7L, X6L, X5L, & X6R

Bullfrog Spas reserves the right to change features, specifications & design without notification and without incurring any obligation.

# IMPORTANT SAFETY INSTRUCTIONS

Save these instructions

## Safety Instructions

When installing and using this electrical equipment, basic safety precautions should always be followed, including the following:

1. Read and follow all instructions:
2. **▲ WARNING:** To reduce the risk of injury, do not permit children to use this product unless closely supervised at all times.
3. As per UL requirements (U.S.), a wire connector is provided on this unit to connect a minimum No. 8 AWG (8.4mm<sup>2</sup>) solid copper conductor between this unit and any metal equipment, metal enclosures of electrical equipment, metal water pipe, or conduit within 5 feet (1.5m) of the unit.
4. **▲ WARNING:** For products provided with a cord-connected, ground-fault circuit-interrupter, the GFCI must be tested before each use. If the GFCI fails to operate properly, disconnect the power until the fault has been identified and corrected.
5. **▲ DANGER:** Risk of Accidental Drowning. Extreme caution must be exercised to prevent unauthorized access by children. To avoid accidents, ensure that children cannot use this spa unless they are supervised at all times.
6. **▲ DANGER:** Risk of Injury. The suction fittings in the spa are sized to match the specific water flow created by the pump. Should the need arise to replace the suction fittings or the pump, be sure that the flow rates are compatible. Never operate the spa if the suction fittings are broken or missing. Do not replace a suction fitting with one rated less than the flow rate marked on the original suction fitting.
7. **▲ DANGER:** Risk of Electric Shock. As per UL requirements (U.S.), install spa at least 5 feet (1.5m) from all metal surfaces. A spa may be installed within 5 feet (1.5m) of metal surfaces if each metal surface is permanently connected by a minimum of No. 8 AWG (8.4mm<sup>2</sup>) solid copper conductor to the wire connector on the terminal box that is provided for this purpose.
8. **▲ DANGER:** Risk of Electric Shock. Do not permit any electrical appliances, such as a light, telephone, radio, or television within 5 feet (1.5m) of the spa. These units DO NOT have an integral ground fault circuit interrupter. The installation of an integral ground fault circuit interrupter MUST be completed by a qualified Electrician and must meet all applicable electrical codes.
9. For Cord-Connected units:
  - a. Replace damaged cord immediately.
  - b. Do not bury cord.
  - c. Connect to grounded, grounding-type receptacle only.
10. **▲ WARNING:** To Reduce the Risk of Injury:
  - a. Water temperature in a spa should never exceed 104°F (40 ° C). Water temperatures between 100° F (38°C) and 104°F (40°C) are considered safe for a healthy adult. Water temperature in excess of 104° F (40° C) may be harmful to your health. Lower temperatures are recommended for young children and/or when spa use exceeds 10 minutes.
  - b. High temperatures could have a potential for causing fetal damage during pregnancy. Pregnant women or women that could be pregnant should consult a physician and possibly limit spa usage when temperatures are in excess of 100° F (38° C).
  - c. Before entering the spa, measure the water temperature with an accurate thermometer since tolerances of water temperature regulating devices may vary.
  - d. Use of alcohol, drugs, or medication before or during spa use may lead to unconsciousness with the possibility of drowning.
  - e. Persons suffering from obesity or a medical history of heart disease, low or high blood pressure, circulatory system problems, and/or diabetes should consult a physician before using a spa.
  - f. Persons using medication should consult a physician before using a spa. Some medications may induce drowsiness while other medication may affect heart rate, blood pressure, and/or circulation.
11. **▲ WARNING:** PEOPLE WITH INFECTIOUS DISEASES SHOULD NOT USE A SPA OR HOT TUB.
12. **▲ WARNING:** TO AVOID INJURY, EXERCISE CARE WHEN ENTERING OR EXITING THE SPA OR HOT TUB. NEVER DIVE OR JUMP INTO THE SPA.
13. **▲ WARNING:** DO NOT USE A SPA OR HOT TUB IMMEDIATELY FOLLOWING STRENUOUS EXERCISE.
14. **▲ WARNING:** PROLONGED IMMERSION IN A SPA OR HOT TUB MAY BE HARMFUL TO YOUR HEALTH.
15. **▲ CAUTION:** MAINTAIN WATER CHEMISTRY IN ACCORDANCE WITH MANUFACTURER'S INSTRUCTION.
16. **▲ CAUTION:** ADEQUATE DRAINAGE MUST BE PROVIDED IF THE EQUIPMENT IS TO BE INSTALLED IN A SPAVAULT OR BELOW GROUND LEVEL.
17. **▲ WARNING:** Risk of Fatal Hyperthermia. Hyperthermia occurs when the internal temperature of the body reaches a level several degrees above the normal body temperature of 98.6° F (37° C). The symptoms of Hyperthermia include dizziness, lethargy, drowsiness, and fainting. The use of alcohol, drugs, and/or medication can greatly increase the risk of fatal Hyperthermia.



### **The effects of Hyperthermia include:**

- a. Unawareness of impending hazard
  - b. Failure to perceive heat
  - c. Failure to recognize the need to exit the spa
  - d. Physical inability to exit the spa
  - e. Fetal damage in pregnant women
  - f. Unconsciousness and danger of drowning
18. **▲ WARNING:** Risk of Children Drowning. Your spa cover is not rated as a safety cover. It is suggested to always keep the spa cover securely fastened when not in use. This will discourage children from attempting to enter the spa unsupervised. If cover is damaged it should be replaced.
  19. **▲ WARNING:** Risk of Drowning. Use caution when bathing alone. Overexposure may cause nausea, dizziness, and fainting.
  20. **▲ CAUTION:** Risk of Injury. Young children should always be supervised so that they do not play in or around the spa.
  21. **▲ WARNING:** Keep all glassware and other breakable objects away from the spa area.
  22. **▲ WARNING:** Risk of Injury: Short-term inhalation of high concentrations of ozone and long-term inhalation of low concentrations of ozone can cause serious physiological effects.
  23. **▲ CAUTION:** Unauthorized Access. Secure the spa area against unauthorized access. Make sure all spa barriers (fences, enclosures, etc.) meet all applicable national and local codes. Keep spa cover on and locked when it is not being used.
  24. **▲ CAUTION:** Risk of Damage to Spa or Equipment. By performing maintenance as described in this manual, the chance of damage to your spa and its equipment will be reduced. Never block the air vents that lead to the spa's equipment compartment, doing so may cause the spa to overheat.
  25. **▲ WARNING:** Risk of Electric Shock or Death. Do not operate spa during severe weather conditions (e.g. electrical storms, tornadoes, etc.).
  26. **▲ CAUTION:** Non-Approved Accessories. Using accessories not approved by Bullfrog International, LC could void your warranty or cause other problems. Please consult your authorized Bullfrog Spa dealer.
  27. **▲ CAUTION:** Spa Location. Locate your spa on a foundation that can support the maximum filled weight of your spa along with the weight of all the occupants using the spa (see Site Selection and Preparation). Also, locate your spa in an environment that can withstand repeated exposure to water and the possibility of a major spill.
  28. **▲ CAUTION:** Power cords must be replaced only with a special cord assembly available from the Manufacturer, its Service Agent, or similarly qualified persons in order to avoid a hazard.

29. **▲ WARNING:** This appliance is not intended for use by young children or unhealthy persons without supervision.
30. **▲ WARNING:** Before obtaining access to supply terminals, all supply circuits must be disconnected.
31. **▲ WARNING:** Risk of Injury or Accidental Drowning: Do not use spa without filters, filter plate, and filter SnapCaps™ installed; these parts serve as a barrier against bodily entrapment against the filter suction fitting(s).
32. **▲ CAUTION:** Test the GFCI or RCD ( Residual Current Device) before each use of the spa.

## **Additional Instructions**

### **(Canadian Installations Only):**

33. A green-colored terminal or a terminal marked G, GR, Ground, Grounding or the international grounding symbol is located inside the supply terminal box or compartment. To reduce the risk of electric shock, this terminal must be connected to the grounding means provided in the electric supply service panel with a continuous copper wire equivalent in size to the circuit conductors supplying this equipment.
34. At least two lugs marked "BONDING LUGS" are provided on the external surface or on the inside of the supply terminal box or compartment. To reduce the risk of electric shock, connect the local common bonding grid in the area of the spa or hot tub to these terminals with an insulated or bare copper conductor not smaller than No. 6 AWG.
35. All field-installed metal components such as rails, ladders, drains, or other similar hardware located within 10 feet (3m) of the spa or hot tub must be bonded to the equipment grounding bus with copper conductors not smaller than No. 6 AWG.
36. **▲ WARNING:** Risk to Infants, Elderly, and Women Planning or Experiencing Pregnancy. Please consult your physician if the above applies to you or anyone using the spa

## **Warning Signs (North America)**

Included with the spa is a warning sign to inform users and guest of the risks involved with using a spa. This sign is suitable for indoor and outdoor use. It should be placed in a noticeable place adjacent to the spa. For free additional copies, contact your authorized Bullfrog Spa Dealer.

# ! WARNING

## REDUCE THE RISK OF ELECTROCUTION

1. NEVER PLACE AN ELECTRIC APPLIANCE WITHIN 5 FEET OF SPA

## REDUCE THE RISK OF CHILD DROWNING

1. SUPERVISE CHILDREN AT ALL TIMES.
2. ATTACH SPA COVER AFTER EACH USE.

## REDUCE THE RISK OF OVERHEATING

1. CHECK WITH A DOCTOR BEFORE EACH USE IF PREGNANT, DIABETIC, IN POOR HEALTH, OR UNDER MEDICAL CARE.
2. EXIT IMMEDIATELY IF UNCOMFORTABLE, DIZZY, OR SLEEPY. SPA HEAT CAN CAUSE HYPERTHERMIA AND UNCONSCIOUSNESS
3. SPA HEAT IN CONJUNCTION WITH ALCOHOL, DRUGS, OR MEDICATION CAN CAUSE UNCONSCIOUSNESS.

**WHEN PREGNANT**, SOAKING IN HOT WATER FOR LONG PERIODS CAN HARM YOUR FETUS.

MEASURE WATER TEMPERATURE BEFORE ENTERING.

1. DO NOT ENTER SPA IF WATER IS HOTTER THAN 100°F (38°C)
2. DO NOT STAY IN SPA FOR LONGER THAN 10 MINUTES.

THIS MARKING IS TO BE REMOVED ONLY BY THE OWNER AFTER SAFETY SIGN IS INSTALLED

69.1-S

# ! WARNING

## REDUCE THE RISK OF ELECTROCUTION

1. NEVER PLACE AN ELECTRIC APPLIANCE WITHIN 5 FEET OF SPA

2. DO NOT INSTALL UNDER SPA SKIRT OR WITHIN AN ENCLOSURE THAT WOULD RESTRICT VENTILATION.
3. IF BLOWER IS INCLUDED, INSTALL AT LEAST 1 FOOT ABOVE MAXIMUM WATER LEVEL.

## REDUCE THE RISK OF CHILD DROWNING

1. SUPERVISE CHILDREN AT ALL TIMES.
2. ATTACH SPA COVER AFTER EACH USE.
3. INSTALL A SUCTION GUARD WITH MARKED FLOW RATE NO LESS THAN \_\_\_\_ GPM TO AVOID HAIR & BODY ENTRAPMENT.

## REDUCE THE RISK OF OVERHEATING

1. CHECK WITH A DOCTOR BEFORE EACH USE IF PREGNANT, DIABETIC, IN POOR HEALTH, OR UNDER MEDICAL CARE.
2. EXIT IMMEDIATELY IF UNCOMFORTABLE, DIZZY, OR SLEEPY. SPA HEAT CAN CAUSE HYPERTHERMIA AND UNCONSCIOUSNESS
3. SPA HEAT IN CONJUNCTION WITH ALCOHOL, DRUGS, OR MEDICATION CAN CAUSE UNCONSCIOUSNESS.

**WHEN PREGNANT**, SOAKING IN HOT WATER FOR LONG PERIODS CAN HARM YOUR FETUS.

MEASURE WATER TEMPERATURE BEFORE ENTERING.

1. DO NOT ENTER SPA IF WATER IS HOTTER THAN 100°F (38°C)
2. DO NOT STAY IN SPA FOR LONGER THAN 10 MINUTES.

70.2-E

\* Final warning sticker is included with spa for installation by owner.

# ! WARNING

## REDUCE THE RISK OF ELECTROCUTION

1. NEVER PLACE AN ELECTRIC APPLIANCE WITHIN 5 FEET OF SPA

## REDUCE THE RISK OF CHILD DROWNING

1. SUPERVISE CHILDREN AT ALL TIMES.
2. ATTACH SPA COVER AFTER EACH USE.

## REDUCE THE RISK OF OVERHEATING

1. CHECK WITH A DOCTOR BEFORE EACH USE IF PREGNANT, DIABETIC, IN POOR HEALTH, OR UNDER MEDICAL CARE.
2. EXIT IMMEDIATELY IF UNCOMFORTABLE, DIZZY, OR SLEEPY. SPA HEAT CAN CAUSE HYPERTHERMIA AND UNCONSCIOUSNESS
3. SPA HEAT IN CONJUNCTION WITH ALCOHOL, DRUGS, OR MEDICATION CAN CAUSE UNCONSCIOUSNESS.

**WHEN PREGNANT**, SOAKING IN HOT WATER FOR LONG PERIODS CAN HARM YOUR FETUS.

MEASURE WATER TEMPERATURE BEFORE ENTERING.

1. DO NOT ENTER SPA IF WATER IS HOTTER THAN 100°F (38°C)
2. DO NOT STAY IN SPA FOR LONGER THAN 10 MINUTES.

70.1-0



# GETTING TO KNOW YOUR SPA

## Spa Overview

[A7L Pictured]

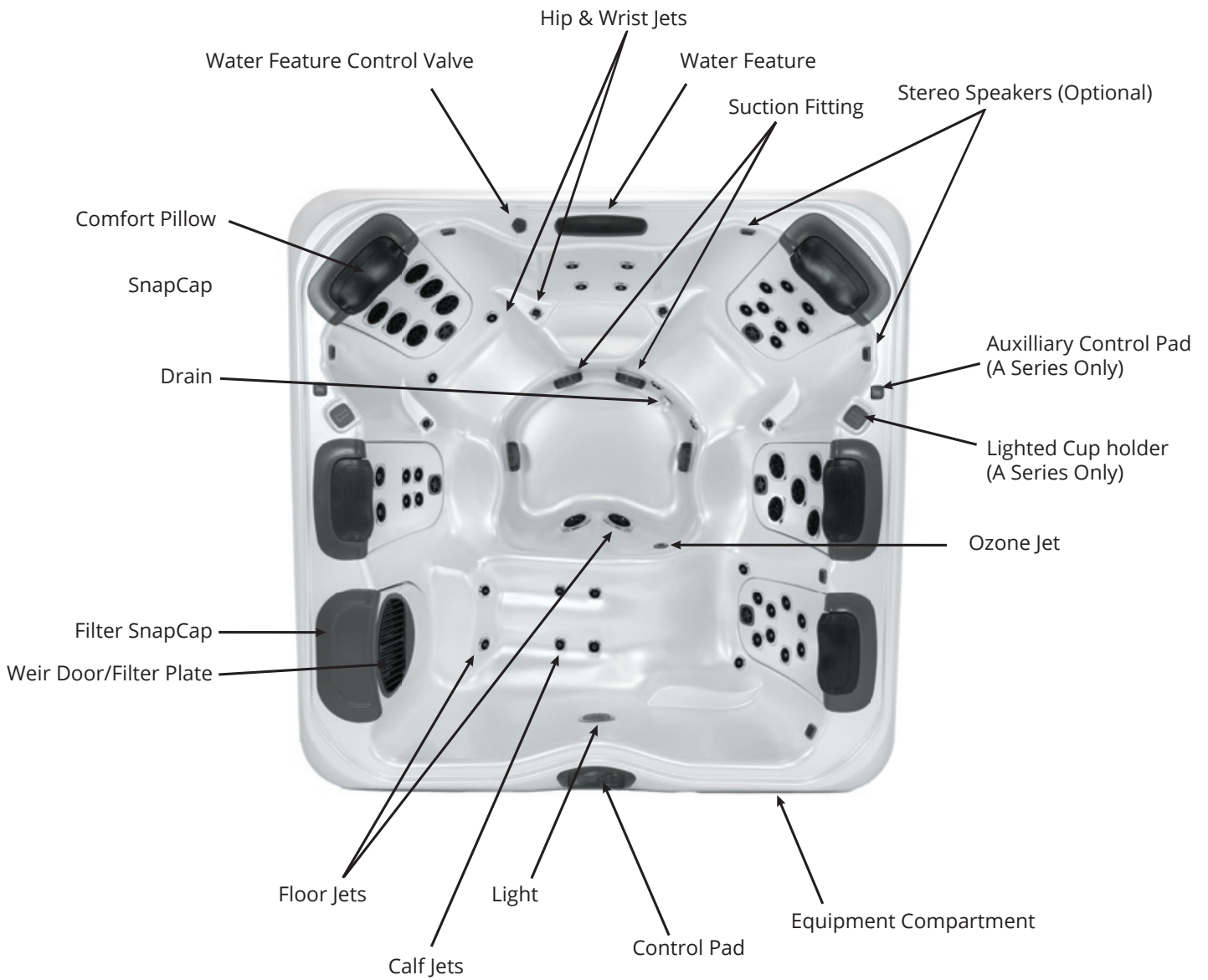

# Spa Overview

[X7L Pictured]

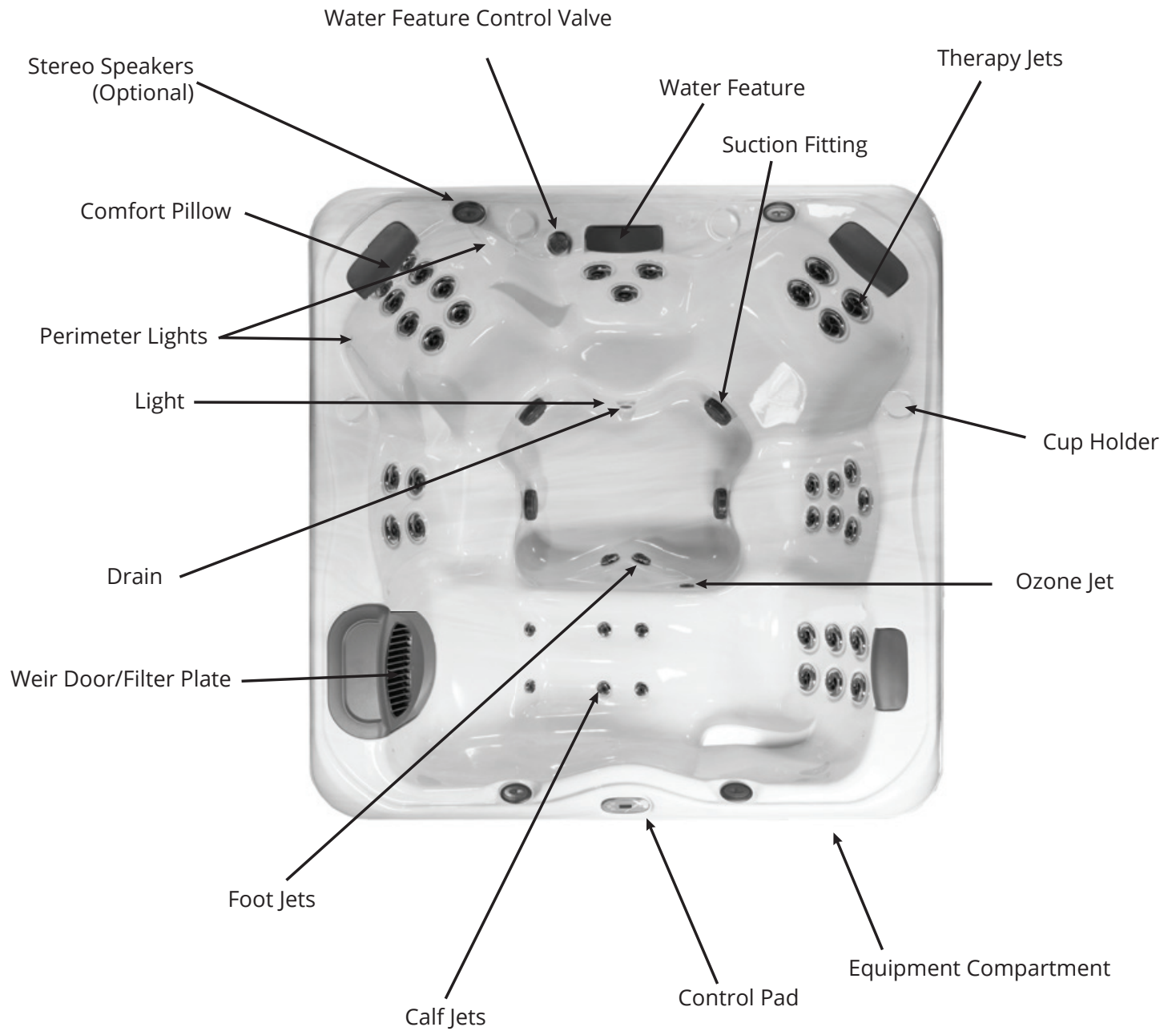



# EQUIPMENT COMPARTMENT

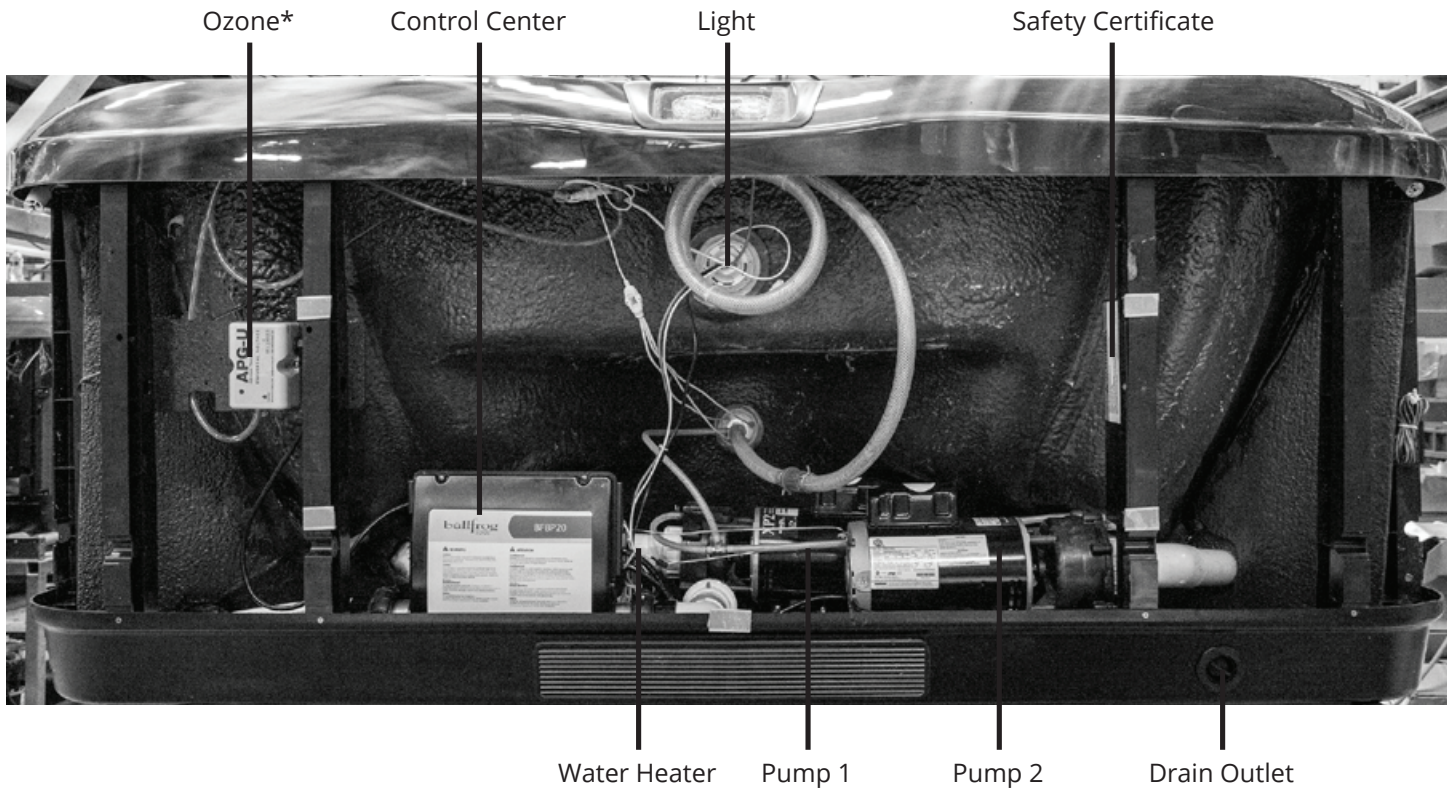

\*Optional

# FILLING YOUR SPA

**WARNING:** An empty spa (spa without water in it) must not be left exposed to sunlight as shell damage may occur. Once the spa is unwrapped, fill spa with water immediately or shade the spa with cover or wrapping to prevent direct exposure to sunlight.

**IMPORTANT:** Do not turn power on to the spa without water in the spa. Serious damage to the pump and heater may occur.

**Step 1:** Fill the Spa: Use a garden hose to fill the spa to the water level indication mark on the faceplate of the filter weir assembly. Be sure to open all valves and jets in the plumbing system before filling to allow as much air as possible to escape from the plumbing during the filling process.

**NOTE:** For complete filling instructions, refer to Changing Spa Water (page 30).

**IMPORTANT:** Never fill the spa with soft water unless an appropriate mineral supplement is immediately added (see your authorized Bullfrog Spas Dealer). If your water is extremely hard, it is preferable to either dilute the water's hardness by blending the water with water from a water softener, or by the addition of a special water softening chemical (see your authorized Bullfrog Spas Dealer).

**Step 2:** Check for Leaks: After the spa is filled, check all fittings and equipment in equipment compartment for signs of leakage before turning on the spa. Turn on pump(s), once again, check for leakage. If a leak is detected, tighten the fitting by hand. If the leak persists contact your authorized Bullfrog Spas Dealer.



**Step 3:** Install Cover: The spa cover comes with tie down straps and locking hardware that attaches the cover to the spa or decking. If your dealer did not install the cover, refer to the Cover



Installation Instructions included with the cover.

Cover locks are an essential component for compliance with the ASTM F1346-91 safety standard for spa covers.

## Control System

**IMPORTANT:** Your Bullfrog Spa is equipped with one of 4 types of control pads: A900 (5 Button), R600 (5 or 6 Button), X300 (3 or 4 Button) or Touch Screen. Locate the control system on your spa by matching it with the photo provided under each control panel section and follow the specific instructions for operation of your specific control system.

Your spa is pre-programmed with default filter cycles and temperature settings. The following control panel instructions will detail the procedures to alter such default settings.

# STIL/A SERIES TOUCH CONTROL PANELS

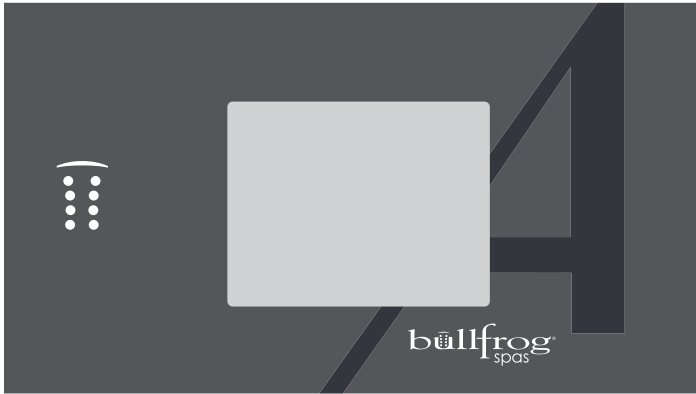

## Preparation

### To operate:

Ensure the spa is filled to its correct operating level. After turning the power on at the main power panel, the control panel will display a splash, or startup screen. As you begin to operate the control, push each icon (button) slowly and deliberately with your finger.

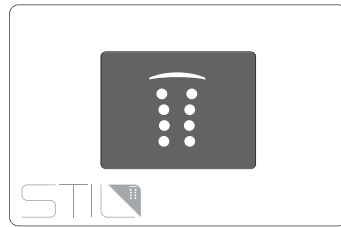

## Priming the Pumps

As soon as the spa has power, it will enter “Priming Mode.” If your spa is equipped with two pumps, two icons will appear in the touch screen. Press  “Prime Jets” button once to start Pump 1 in low-speed, and then a second time to set it to high speed. If your spa is equipped with a second pump, follow the procedure again for that pump. All pumps should be running in at their highest speed to facilitate priming.

**IMPORTANT:** A pump should not be allowed to run without priming (water flowing out of the jets) for more than 2 minutes. Under NO circumstances should a pump be allowed to run without priming beyond the end of the 4-5 minute priming mode. Doing so may cause damage to the pump and cause the system to energize the heater and go into an overheat condition.

**NOTE:** Turning the power off and back on again will initiate a new pump priming session. Sometimes momentarily turning the pump off and on will help it to prime. Do not do this more than 5 times. If the pump(s) will not prime, shut off the power to the spa and call for service. Once the system has exited Priming Mode, the control panel will display the Main Screen. The temperature will not be displayed but will show four dashes as pictured below.



The system requires approximately 1-2 minutes of water flowing through the heater to determine and display the correct water temperature.

## The Main Screen

Important information about spa operation can be seen quickly from the main screen. Push  icon from any screen to return to the main menu.

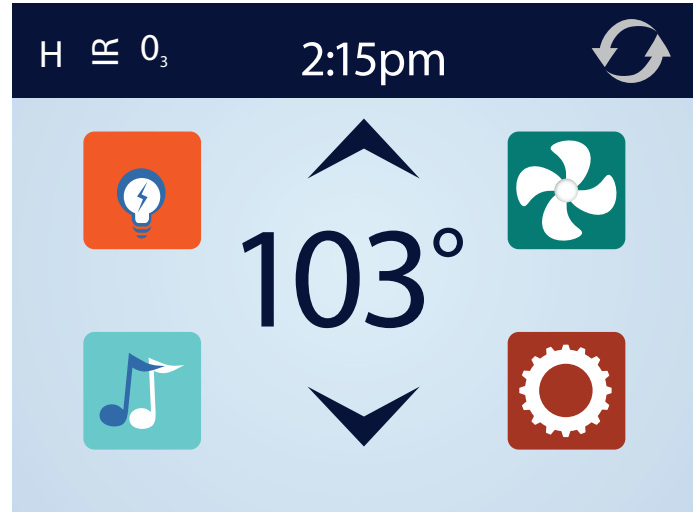

## The Settings Screen

The “Settings” screen is accessed by pressing the  icon. The Settings menu is where spa settings and programming are controlled.

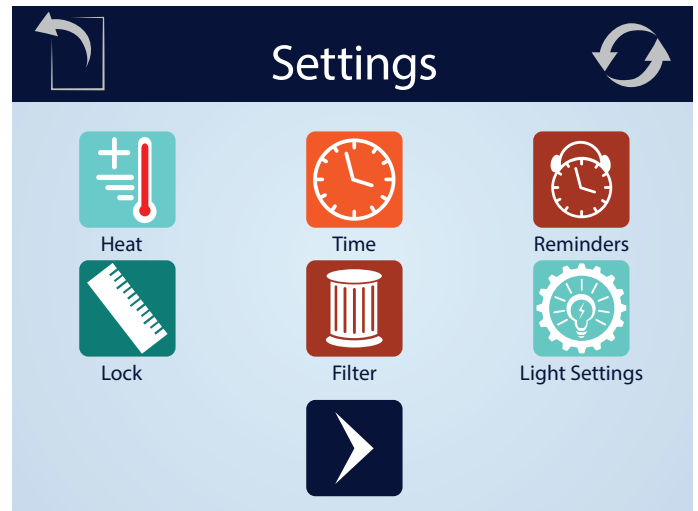

## Temp Settings

To adjust the temperature of your spa, use the up and down arrows on main screen. Set temperature will temporarily display when setting. Actual water temperature will return to the display several seconds after you are finished adjusting the set temperature, and water has been running through the pumps.

## Dual Temperature Range

Your spa comes equipped with two pre-programmed temperature ranges, High and Low. When a temperature range is selected, the spa will heat to the temperature associated with that range and remain at that temperature. High Range can be set between 80°F (26.7°C) and 104°F (40°C). Low Range can be set between 50°F (10°C) and 99°F (37.2°C). The most common use for the low range is during vacations or extended periods of inactivity. Freeze Protection is active in either range.

## Heat Mode Ready vs. Rest

When in “Ready” mode, the pump that circulates water through the heater (heater pump) will turn on every 1/2 hour to measure water temperature, heat if needed, and refresh the temperature display. When in Ready mode your spa will continually maintain its set temperature.

“Rest” mode is an economy mode in which the spa only circulates and heats water during designated filter cycles. As a result, in the time period between filtration cycles the control may not display the correct water temperature unless the heater pump is on and has been running for up to two minutes. When in Rest mode your spa will heat to its set temperature twice per day during programmed filter cycles.

## Ready-in-Rest Mode





When the spa is in Rest mode and a “Jet” button is manually pressed, the spa will enter Ready-in-Rest mode and heat up to the selected temperature, allowing for use in periods outside of scheduled filter cycles.

## Light Settings

The spa lights are activated by pressing the  icon. Pressing this icon turns off or on your interior or exterior lights manually. By turning the light off and then on again, you can choose the light color and display properties. Each time the light is turned off and on it will advance according to the following sequence:

1. Color wheel: Color changes quickly through available solid colors.
2. Color fade: Colors fade through spectrum A colors.
3. Random Color Change: Random color changes occur in quick succession.
4. Spectrum fade: Colors fade through spectrum B colors.
5. Solid Color: Red
6. Solid Color: Green
7. Solid Color: Blue
8. Solid Color: Yellow
9. Solid Color: Indigo
10. Solid Color: Orange
11. Solid Color: Violet
12. Solid Color: White





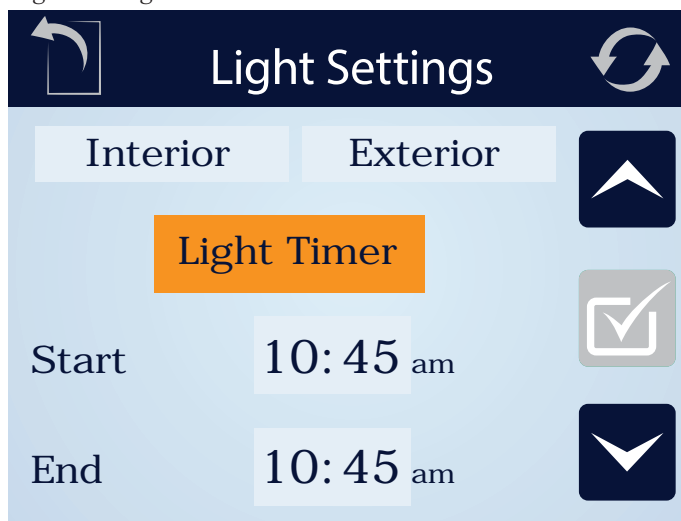

## Light Settings (A-Series)

A-Series spas come equipped with a light timer. To set the light timer, from the main menu, select  and then . To enable the timer, press the [Disabled] icon. Set the desired time and duration or the timer by pressing on the pad above the time you wish to adjust and then using the  and  icons to choose the desired time and duration. Press the  icon to confirm your selections.

## Light Settings (STIL)







STIL spas come equipped with the ability to independently control the interior and exterior lights with a light timer. The  button on the main control screen will operate the interior and exterior lights according to the setting designated in the Light Settings screen.



To set the light timer, from the main menu, select  and then . To change the interior/exterior setting or to set the light timer, from the main menu, select  and then . To engage the interior lights press the Interior button. To engage the exterior lights press the Exterior button. To enable the timer, press the [Disabled] icon. Set the desired time and duration or the timer by pressing on the pad above the time you wish to adjust and then using the  and  icons to choose the desired time and duration. Press the  icon to confirm your selections. The light timer will turn on the interior and exterior lights according to the current Interior and Exterior button positions.

## Time Settings

### Setting the time of day

Setting the time is important for filtration settings and other background settings to function as expected. To set the time, from the main menu, press the  icon, followed by the  icon. This will bring you to the “Time of Day” menu. Select the correct time by pressing on the hour or minutes, and then using the  and  buttons to select the correct time. Holding the  or  buttons will allow you to more quickly move through time. Press the  icon to confirm your changes.

## Filtration Cycles

Your Spa comes factory programmed to run two cycles in each 24 hour period.

**Filter Cycle 1:** Begins at 6:00pm (18:00) and runs for 2 hours. (3 hours for spas equipped with the optional WellSpring Filtration Pump.)







**Filter Cycle 2:** Begins at 8:00am (8:00) and runs for 1 hour.



These factory set filtration cycles should be adequate for light to normal spa use (spas used once to twice per week). For cases of more frequent, to heavy spa usage, you may need to increase the filter cycle durations to maintain water clarity.

## Changing Filter Cycles:

### To change filter 1 cycle:

From the main menu, press “Settings”  followed by . This will take you to the “Filtration” menu. Select the “Filter Cycle 1” by pressing [1]. Adjust the time and duration by pressing on the hour or minutes, and then using the  and  buttons to select the correct time and duration. Press the  icon to confirm your changes.

### To change filter 2 cycle:



Select the “Filter Cycle 2” by pressing [2]. Adjust the time and duration by pressing on the hour or minutes, and then using the  and  buttons to select the correct time and duration. Press the  icon to confirm your changes.

## Purge Cycles

In order to maintain sanitary conditions and protect against freezing, your spas pumps will purge water from their respective plumbing by running all pumps at the beginning of each filter cycle. If the Filter Cycle 1 is set for 24 hours, enabling Filter Cycle 2 will initiate a purge when Filter Cycle 2 is scheduled to begin.



## To Change Preferences

To change temperature display between Fahrenheit (F) and Celsius (C), 24 or 12 hour clock :

From the main menu, press . In the Settings menu press the  key to move to the second page of the menu. Press the  icon. The “Units” menu will then be displayed. To change the temperature setting, press the temperature unit which is currently displayed. This will change it from C° to F° or vice versa.

To change the time display press on the currently selected hour unit.

## To Set Reminders

From the main menu, press  , then in the “Settings” menu, press the  icon. Next, press the portion of the panel where “Yes” or “No” is displayed. This will toggle the reminders to trigger, or turn them off.





## Hold



The “Hold” function prevents the jets from running to allow JetPaks to be swapped out. By default, a hold lasts 60 minutes, or until the  button is pressed.

## Restricting Operation





The control panel can be restricted to prevent unwanted use or temperature adjustments. “Panel Lock” prevents most functions on the controller from being used, while all automatic functions remain active. “Lock Settings” in contrast, allows the jets and lighting to be adjusted, while other features are inactive.

### To lock the settings, from the Main Menu

Press  , followed by  . The “Settings” lock and “Panel” lock options will be displayed in the menu. Press  to lock the settings in their current configuration, or  to lock the panel. While the panel is locked, the only buttons that will function are the buttons that lead to the locking screen.

To cancel either of the lock settings, navigate to the Lock menu by pressing  followed by  . Press the corresponding icon to release the lock.

## GFCI TEST







The installer can cause the GFCI Trip Test to occur sooner by initiating manually. To initiate the test press the  icon. In the Settings menu press the  key to move to the second page of the menu. Press  , this will bring up the “Utilities” menu. Press  . In the “GFCI Test” menu you will see the status of the GFCI test. If the GFCI test has not been previously triggered, it will indicate a status of “Armed.” Press  to begin the GFCI Test.

The GFCI should trip within several seconds and the spa should shut down. If it does not, a warning indicator will appear on the bottom left of the touch pad. Shut down the spas power and manually verify that a GFCI breaker is installed and that the circuit and spa are wired correctly. Verify the function of the GFCI with its own test button. Restore power to the spa and repeat the GFCI Trip Test. Once the GFCI is tripped by the test, reset the GFCI and the spa will operate normally from that point. You can verify a successful test by navigating to the “Fault Log” menu. “The GFCI test passed” should in the log if the test passed. The end-user must be trained to expect this one-time test to occur and how to properly reset the GFCI.





## Invert Display



To inver the display, from any screen press the  icon.

## Fault Log







To access the fault log, press  . In the Settings menu press the  key to move to the second page of the menu. Press the  icon. In the Utilities menu, press the  icon. Events recorded in the log can be accessed by pressing  or  buttons.

## Panel Sleep

Your touch panel comes pre-programmed to go to sleep after 30 minutes of disuse. To change this setting, press  . In the Settings menu press the  key to move to the second page of the menu. Press the  icon to enter the Utilities menu. Press the  icon. You can adjust the length of time

before your panel goes into sleep mode by pressing the  or  icons. Press the  to confirm your setting.

## Language

To change the display language, press the  menu. In the Settings menu press the  key to move to the second page of the menu. Press the  icon. You can scroll through the available language selections by pressing the  or  keys. Select your preferred language by pressing its name in the menu. Press  to confirm your selection.

## Stereo Controls (Optional)

If your spa is equipped with Bullfrog's "Elite" Audio system, refer to its separate manual for operating instructions. If your spa has Bullfrog's "Life" Audio system, the spa's Touch control pad will control various functions of Bluetooth connected devices.

The first time you use your Bluetooth device with Bullfrog's Life Audio system you must first "pair" your device to the spa audio system. Each device must be paired separately.

Turn on your Bluetooth device and place within 20 feet (6 meters) of your spa. The device must have "line of sight" to the spa control panel/equipment door area.

**NOTE:** Certain house construction materials and other obstructions can impair Bluetooth connectivity. You may need to experiment with where to place your BT device for best results.

From the main menu, press and hold the  icon. After approximately 15-20 seconds, "PPGME60" will appear in your Bluetooth devices list. Select "PPGME60" from your device's list to connect and "pair" your device to Bullfrog's Life Audio system.

After a few seconds the pairing will complete and audio from your device will start playing on the spa audio system. Your Bluetooth devices need only be paired the first time you use a new device. After that your device will connect automatically.



# A SERIES SPAS- A900 CONTROL PANELS

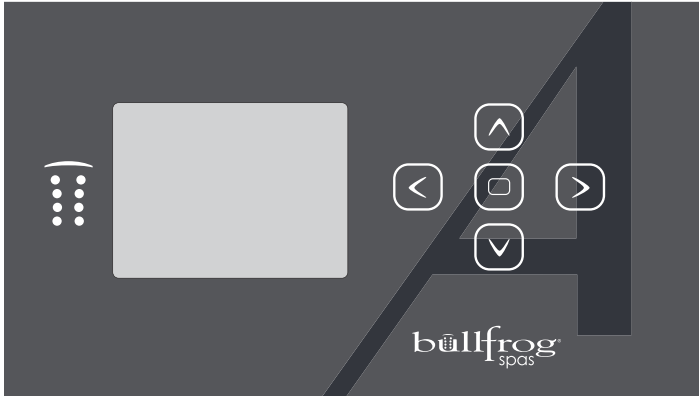

from the Main Screen. The most important features, including Set Temperature adjustment, can be accessed from this screen. The actual water temperature can be seen in large text and the desired, or Set Temperature, can be selected and adjusted. Time of day, ozone operation, and filter operation status is available, along with other messages and alerts. High temperature Range vs. Low temperature Range is indicated in the upper right corner. The Jets Icon in the center will spin on if any pump is running and changes color when the heater is on. A Lock icon is visible if the panel or setting is locked.

## Preparation

Ensure the spa is filled to its correct operating level. After turning the power on at the main power panel, the control panel will display a splash, or startup screen.

## Priming Mode

As soon as the spa has power, it will enter Priming enter "Priming Mode." If your spa is equipped with two or more pumps, two icons labeled "Jets 1" and Jets 2" will appear in the display window. Press to select "Jets 1" press to activate pump 1 on low. Press again to move the pump into high mode. If your pump is equipped with a second pump, press to select the "Jets 2" icon. Press twice to put the pump on high speed. All pumps should be running in at their highest speed to facilitate priming.

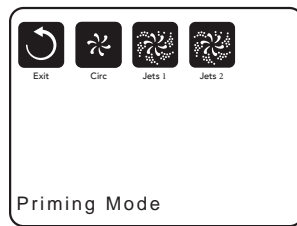

**IMPORTANT:** A pump should not be allowed to run without priming (water flowing out of the jets) for more than 2 minutes. Under NO circumstances should a pump be allowed to run without priming beyond the end of the 4-5 minute priming mode. Doing so may cause damage to the pump and cause the system to energize the heater and go into an overheat condition.

**NOTE:** Turning the power off and back on again will initiate a new pump priming session. Sometimes momentarily turning the pump off and on will help it to prime. Do not do this more than 5 times. If the pump(s) will not prime, shut off the power to the spa and call for service. Once the system has exited Priming Mode, the control panel will display the Main Screen. The temperature will not be displayed but will show four dashes as pictured below. The system requires approximately 1-2 minutes of water flowing through the heater to determine and display the correct water temperature.

---°F---°C

## The Main Screen

Important information about spa operation can be seen quickly

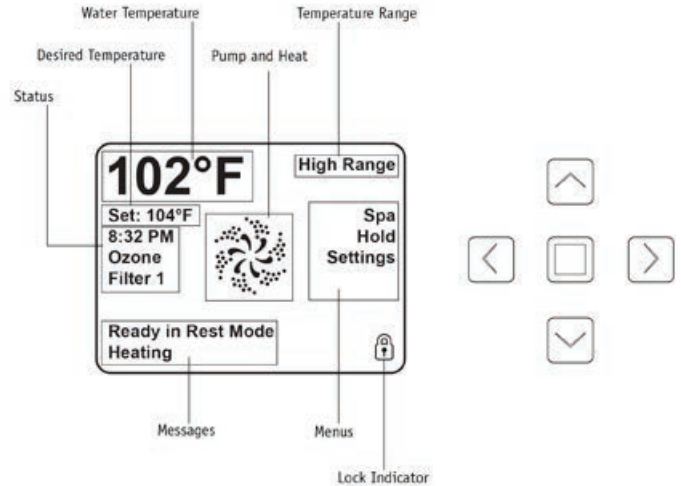

The menu choices on the right can be selected and the screen will change to show more detailed controls or programming functions.

## Navigation

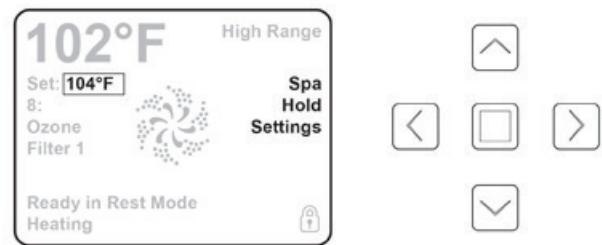



Navigating the entire menu structure is done with the 5 buttons on the control panel. When a text item changes to white during navigation, that indicates the item is selected for action. Operating or changing a selected item is generally done with the center or "Select" button. The only item that can be changed on the left side of the Main Screen is the Set Temperature. Press the Left Arrow button to change the Set Temperature number to white. The Set Temperature can then be adjusted with the up and down buttons. Pressing the Select button or the Right Arrow button will save the new set temperature. On the right side of the screen, the menu selections can be selected with the Up and Down Buttons. Use the Select Button to choose an item. Selecting one of these items will change to a different screen with additional controls.

## Messages

At the bottom of the screen, messages may appear at

various times. Some of the messages must be dismissed by the user.

## Press-and-Hold

If an  Up or  Down button is pressed and held when the Set Temperature is selected, the temperature will continue to change until the button is released, or the Temperature Range limits are reached.

## The Spa Screen

### One Press Activation

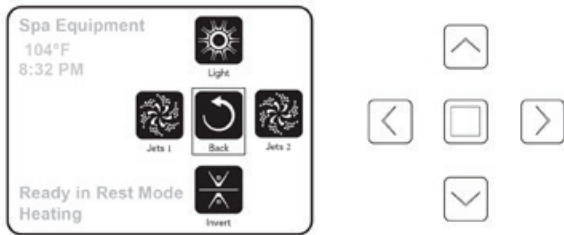

The Spa Screen shows all available equipment to control, as well as Invert, in one easy-to-use screen. Each button is fixed on a specific function and can be used as a very simple user interface for the spa. The display shows icons that are related to the equipment installed on a particular spa model, so this screen may change depending on the configuration.



The pumps have more than one ON state, so the icon will change to reflect the state that the equipment is in. Below are some examples of 2-speed Pump indicators:

**NOTE:** The icon for the pump that is associated with the heater (Filtration Pump) will have a red glow in the center when the heater is running.

## Light Operation

By turning the light on and off, it will change the sequence of colors from flashing, to fading, to solid color in the following sequence:

1. Color wheel: Color changes quickly through available solid colors.
2. Color fade: Colors fade through spectrum A colors.
3. Random Color Change: Random color changes occur in quick succession.
4. Spectrum fade: Colors fade through spectrum B colors.
5. Solid Color: Red
6. Solid Color: Green
7. Solid Color: Blue
8. Solid Color: Yellow
9. Solid Color: Indigo
10. Solid Color: Orange
11. Solid Color: Violet
12. Solid Color: White

## The Screen

The Settings Screen is where all programming and other spa behaviors are controlled. This screen has several features that can be acted on directly. These features include Temp Range, Heat Mode, and Invert Panel. When one of these items is highlighted, the  Select Button is used to toggle between two settings. All other menu items (with an arrow pointing to the right) will take you to another level in the menu.

### Press-and-Hold

If an Up or Down button is pressed and held when an item in a Menu List is highlighted, the list can be scrolled quickly from top to bottom. The scroll bar on the right side of the screen indicates the relative position of the highlighted item in the list.

## Dual Temperature Range (High vs. Low)

Your spa comes equipped with two temperature range settings with independent set temperatures. The specific range can be selected on the Settings screen and is visible on the Main Screen in the upper right corner of the display.

### Heat Mode – Ready vs. Rest

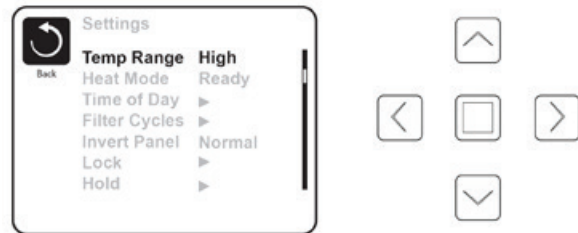

When in “Ready” mode, the pump that circulates water through the heater will turn on every 1/2 hour to measure water temperature, heat if needed, and refresh the temperature display. When in Ready mode your spa will continually maintain its set temperature. REST mode is recommended for most economic performance.



### Ready-in-Rest Mode

When the spa is in Rest mode and a “Jet” button is manually pressed, the spa will enter Ready-in-Rest mode and heat up to the selected temperature, allowing for use in periods outside of scheduled filter cycles.

### Time Settings

Setting the time is important for filtration settings and



other background settings to function as expected. “Set Time” will appear on the display if no time-of-day is set in the memory. From the main menu, navigate to the Settings line by using the  $\uparrow$  and  $\downarrow$  keys. Press  $\square$  to enter the Settings Menu. On the Settings Screen, select the Time of Day line using the  $\uparrow$  and  $\downarrow$  keys. Press  $\square$  to enter the Time of Day menu. On the Time of Day screen, simply navigate  $\rightarrow$  and  $\leftarrow$  right and left to select the Hour, Minutes, AM/PM and 12/24 Hour segments. Use the Up and Down Buttons to make changes.

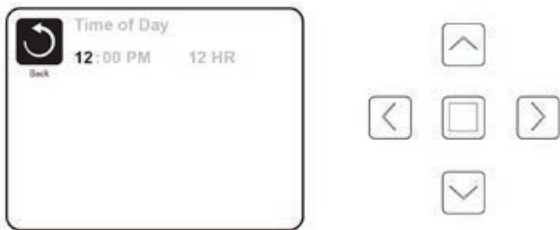

When changes are made, the “Back” button will be replaced by a “Save” button and a new icon for “Cancel” appears under the Save icon. Press  $\square$  while the Save button is selected to confirm your selection.

## Light Timer

Your spa is equipped with a timer that, when engaged, will turn the interior and exterior lights on and off. To set the light timer, from the main menu, use the  $\uparrow$  or  $\downarrow$  buttons to select “Settings,” press  $\square$ , to enter the Settings Menu. Press  $\rightarrow$  to enter the menu list. Use the  $\uparrow$  and  $\downarrow$  buttons to select “Light Cycle”. Press  $\square$  to enter the menu. Press  $\rightarrow$  to enter the menu list. Press  $\uparrow$  or  $\downarrow$  to enable the Light Timer. Press  $\rightarrow$  to select the hour, minute, and duration of the light cycle. When changes are made, the “Back” button will be replaced by a “Save” button and a new icon for “Cancel” appears under the Save icon. Press  $\square$  while the Save button is selected to confirm your selection.

## Saving Settings

Throughout your use of the settings screen, save your settings by following these steps:

When changes are made, the icon to go “Back” changes to “Save” and a new icon for “Cancel” appears under the Save icon. Navigating to the left will highlight the Save icon, and navigating down from there will allow the user to cancel the pending change. Pressing the “Select” button will save or cancel the changes and go back to the previous screen.

## Adjusting Filtration

**NOTE:** Your spa’s factory default filter cycle start times are 8:00am and 6:00pm daily. When using the most economical “rest” mode, it is recommended that you adjust the filtration cycles to run just prior to the time of your usual spa use.

### Filter Cycle 1

Using the same navigation and adjustment as Setting the Time, Filter Cycles are set using a start time and a duration. Each

setting can be adjusted in 15-minute increments. The panel calculates the end time and displays it automatically.

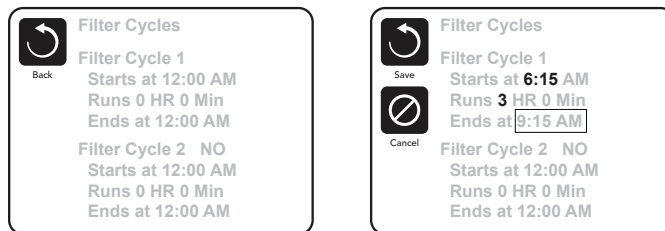

### Filter Cycle 2

Simply navigate to the Filter Cycle 2 line by pressing the Right Navigation button, and when “Yes” is highlighted, press Up or Down to toggle Filter Cycle 2 on and off. When Filter Cycle 2 is ON, it can be adjusted in the same manner as Filter Cycle 1 by navigating to the right. It is possible to overlap Filter Cycle 1 and Filter Cycle 2, which will shorten overall filtration by the overlap amount.

### Purge Cycles

In order to maintain sanitary conditions, as well as protect against freezing, secondary water devices will purge water from internal spa components by running all pumps at the beginning of each filter cycle. If Filter Cycle 1 is set for 24 hours, enabling Filter Cycle 2 will initiate a purge when Filter Cycle 2 is scheduled to begin.

### Restricting Operation

The control can be restricted to prevent unwanted use or temperature adjustments. Locking the Panel prevents the controller from being used, but all automatic functions are still active. Locking the Settings allows Jets and other features to be used, but the Set Temperature and other programmed settings cannot be adjusted.



### Unlocking

An Unlock Sequence using the navigation buttons can be used from the Lock Screen. The Unlock Sequence is the same for both

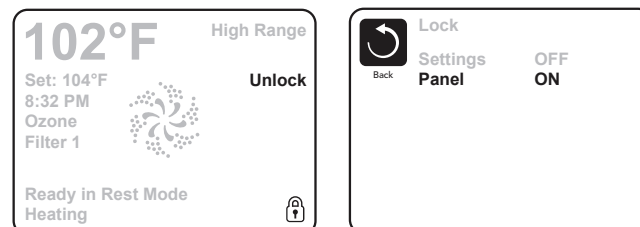

Panel Lock and Settings Lock. You must enter and highlight “Unlock” then enter and highlight panel “ON” before entering the unlock sequence.



## Additional Settings

### Hold Mode

The “Hold” function prevents the jets from running to allow JetPaks to be swapped out. By default, a hold lasts 60 minutes, or until the Exit button is pressed.

### Utilities

The Utilities Menu contains the following:

#### A/B Temps

When this is set to On, the temperature display will alternate to display temperature from Sensor A and Sensor B in the heater.

#### Fault Log

The Fault Log is a record of the last 24 faults that can be reviewed by a service tech.

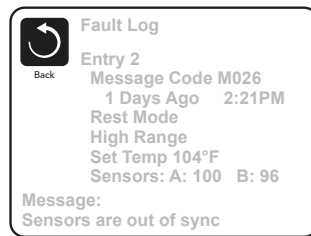

#### GFCI Test

This screen allows the GFCI to be tested manually from the panel and can be used to reset the automatic test feature. If the GFCI Test Feature is reset, the device will trip within 7 days. (See GFCI Test Section)

#### Preferences

The Preferences Menu allows the user to change certain parameters based on personal preference.

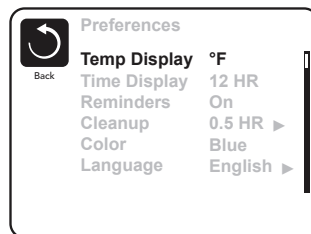

#### Temp Display

Change the temperature between Fahrenheit and Celsius.

#### Time Display

Change the clock between 12 hr and 24 hr display.

#### Reminders

Turn the reminder messages (like “Clean Filter”) On or Off.

#### Cleanup

Cleanup Cycle Duration is not always enabled, so it may not appear. When it is available, set the length of time Pump 1 will run after each use. 0-4 hours are available.

#### Color

Pressing the Select Button when Color is highlighted will cycle

through 5 background colors available in the control.

### Language

Change the language displayed on the panel.

### Information

The System Information Menu displays various settings and identification of the particular system. As each item in the menu is highlighted, the detail for that item is displayed at the bottom of the screen.

#### Software ID (SSID)

Displays the software ID number for the System.

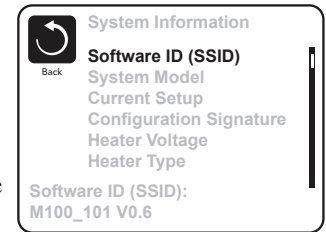

#### System Model

Displays the Model Number of the System.

#### Current Setup

Displays the currently selected Configuration Setup Number.

#### Configuration Signature

Displays the checksum for the system configuration file.

#### Heater Voltage

Displays the operating voltage configured for the heater.

#### Heater Type

Displays a heater type ID number.

#### Dip Switch Settings

Displays a number that represents the DIP switch positions of S1 on the main circuit board.

#### Panel Version

Displays a number of the software in the topside control panel.

### Utilities GFCI Test Feature

The Ground Fault Circuit Interrupter (GFCI) is an important safety device and is required equipment on a hot tub installation.

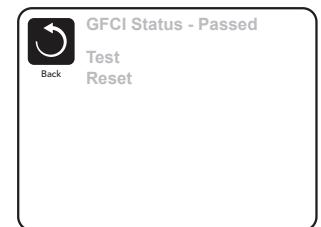

The GFCI Trip Test must occur to allow proper spa function. Within 1 to 7 days after startup, the spa will trip the GFCI to test it. The GFCI must be reset once it has tripped. After passing the GFCI Trip Test, any subsequent GFCI trips will indicate a ground fault or other unsafe condition and the power to the spa must be shut off until a service person can correct the problem. Forcing the GFCI Trip Test (North America Only)

The installer can cause the GFCI Trip Test to occur sooner by initiating it using the above menu. The GFCI should trip within several seconds and the spa should shut down. If it does not, shut down the power and manually verify that a GFCI

breaker is installed and that the circuit and spa are wired correctly. Verify the function of the GFCI with its own test button. Restore power to the spa and repeat the GFCI Trip Test. Once the GFCI is tripped by the test, reset the GFCI and the spa will operate normally from that point. You can verify a successful test by navigating to the above menu. PASS should appear after a temp button is pressed from the GFCI screen.

**WARNING:** If freezing conditions exist, the GFCI should be reset immediately or spa damage could result.

## Stereo Controls (Optional)

For A-Series Spas with optional stereo systems  
 If your spa is equipped with Bullfrog’s “Elite” Audio system, refer to its separate manual for operating instructions. If your spa has a Bullfrog Life Audio system, the spa’s A900 control pad will control various functions of Bluetooth connected devices. From the main screen, select “A/V” using the up or down arrow buttons to the right of the screen. Select “A/V” by pressing the center square button.

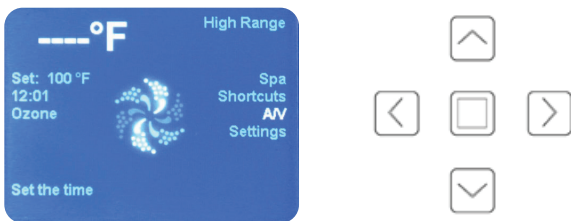

On the A/V screen use the up, down, left, or right arrow buttons to highlight desired function., then press center square button to select.

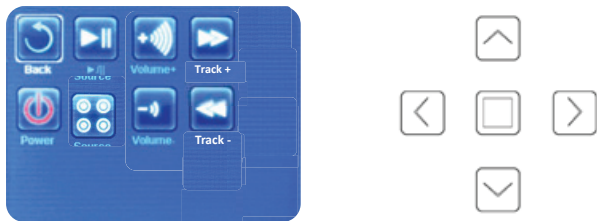

The first time you use your Bluetooth device with Bullfrog’s Life Audio system you must first “pair” your device to the spa audio system. Each device must be paired separately.

1. Turn on your Bluetooth device and place within 20 feet (6 meters) of your spa. The device must have “line of sight” to the spa control panel / equipment door area. (NOTE: Certain house construction materials and other obstructions can impact Bluetooth connectivity. You may need to experiment with where to place your BT device for best results.)
2. From the main spa screen, select “A/V” using the up or down arrow buttons to the right of the screen. Select “A/V” by pressing the  button.

in the Bluetooth device list on your electronic device. Select “PPGME60” from your device’s list to connect and “pair” your device to the Life Audio system. After a few seconds the pairing will complete and audio from your device will start playing on the spa audio system. Your Bluetooth devices need only be paired the first time you use a new device. After that your device will connect automatically.

Refer to the following page for operation of the Life Audio System.

After approximately 15-20 seconds, “PPGME60” will appear

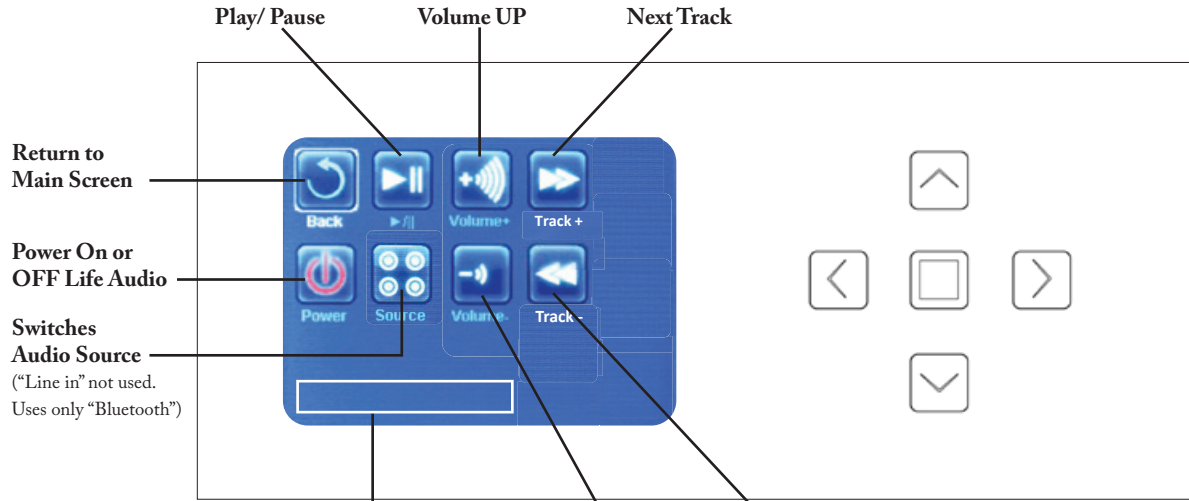

**Life Audio System Status**

**Powering Up-** Connecting, may take 10-15 seconds

**Powering Down-** Turns Life Stereo off

**BT Connected-** Indicates your Bluetooth device is connected

**Discoverable-** System is searching for Bluetooth devices available for pairing (see next page for pairing instructions)



# R SERIES (R600) CONTROL PANELS

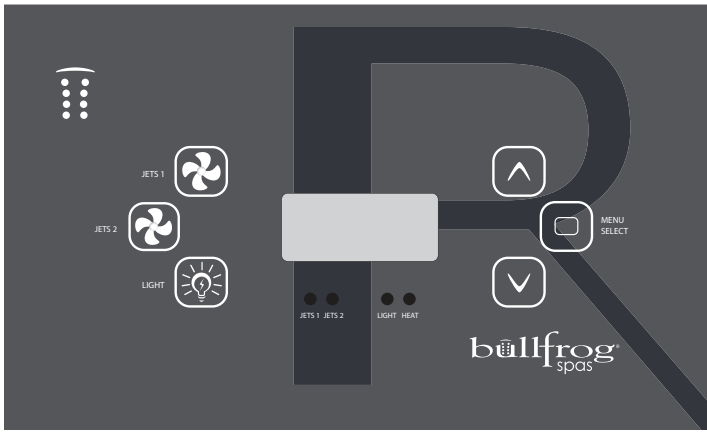

then again to switch to high-speed. Next, if your spa is equipped with a second pump press the Jets 2 or “Aux” button twice, to turn it on high. The pumps will now be running in high-speed to facilitate priming.

**IMPORTANT:** A pump should not be allowed to run without priming (water flowing out of the jets) for more than 2 minutes. Under NO circumstances should a pump be allowed to run without priming beyond the end of the 4-5 minute priming mode. Doing so may cause damage to the pump and cause the system to energize the heater and go into an overheat condition.

**NOTE:** Turning the power off and back on again will initiate a new pump priming session. Sometimes momentarily turning the pump off and on will help it to prime. Do not do this more than 5 times. If the pump(s) will not prime, shut off the power to the spa and call for service.

## Preparation and Filling



Fill the spa to its correct operating level. Be sure to open all valves and jets in the plumbing system before filling to allow as much air as possible to escape from the plumbing and the control system during the filling process. After turning the power on at the main power panel, the control panel display will go through specific sequences. These sequences are normal and display a variety of information regarding the configuration of the hot tub control. After a few seconds, the spa will go into priming mode and will display:



## Priming the Pumps

As soon as the priming mode menu appears on the panel, press the  “Jets 1” button once to start Pump 1 in low-speed and

## Exiting Priming Mode

You can manually exit Priming Mode by pressing the  or  button. Note that if you do not manually exit the priming mode as described above, the priming mode will automatically end after 4-5 minutes. Be sure that the pump(s) have been primed by this time. Once the system has exited Priming Mode, the control panel will momentarily display the set temperature. The system requires approximately 1-2 minutes of water flowing through the heater to determine and display the correct water temperature.

## Light Operation

By turning the light on and off, it will change the sequence of colors from flashing, to fading, to solid color. Use the light button to choose a stationary spa light color or a colored changing series.

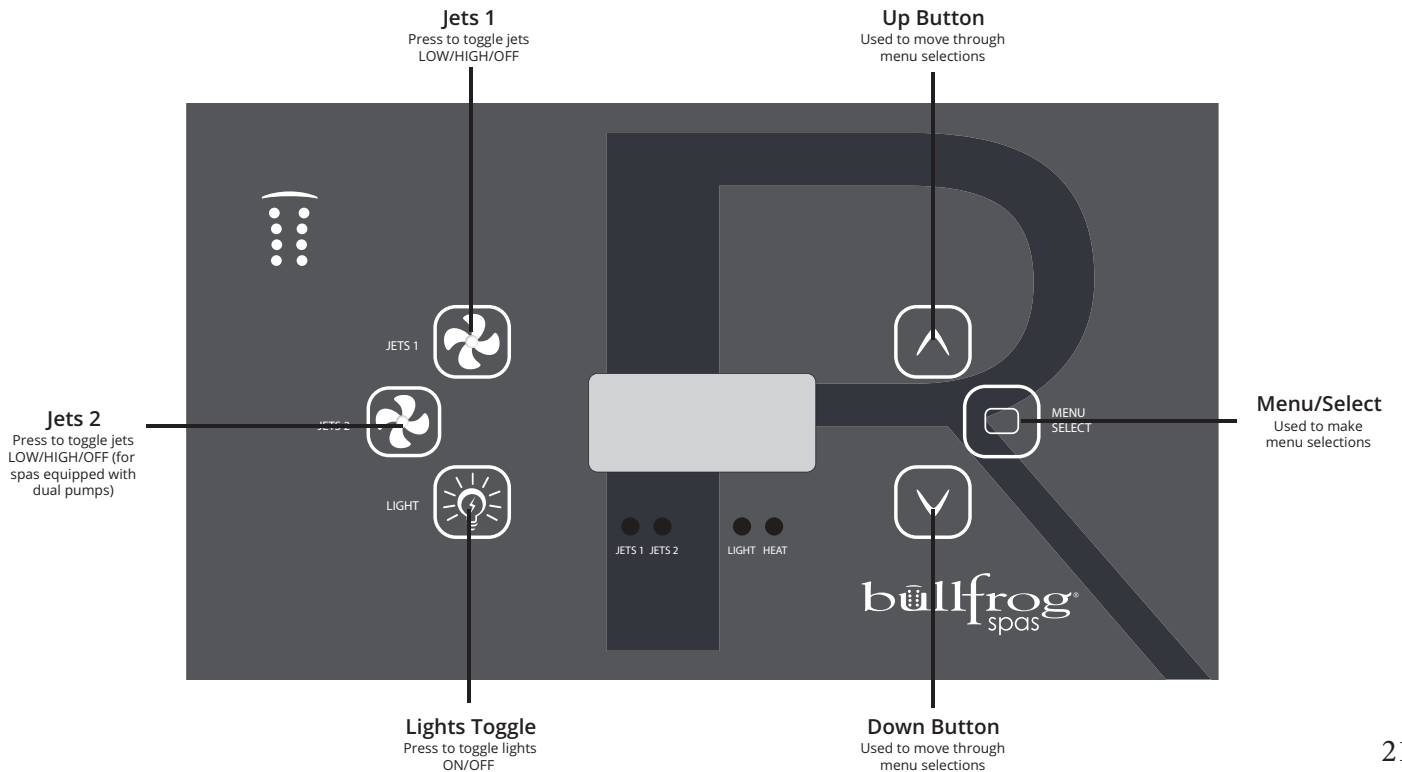



Each time the light is turned off and then on it will advance according to the following sequence:

1. Color wheel: Color changes quickly through available solid colors.
2. Color fade: Colors fade through spectrum A colors.
3. Random Color Change: Random color changes occur in quick succession.
4. Spectrum fade: Colors fade through spectrum B colors.
5. Solid Color: Red
6. Solid Color: Green
7. Solid Color: Blue
8. Solid Color: Yellow
9. Solid Color: Indigo
10. Solid Color: Orange
11. Solid Color: Violet
12. Solid Color: White

## Main Menus





### Navigation

The R600 control pad is navigated by the use of three control buttons.  "Menu Select,"  "Up" and  "Down." If at any time during the control sequences a key is not pressed for several moments, the menu will revert to the display and you will need to start the sequence from the beginning.

## Hold (Standby)







### Hold Mode

The "Hold" function prevents the jets from running to allow JetPaks to be swapped out. By default, a hold lasts 60 minutes, or until the menu is exited manually. To put spa in "HOLD,"







1. 1. Press the "Menu Select"  button once. "HOLD" will flash on the display.
2. 2. Press the up arrow  to enter "HOLD" mode. "HOLD MODE" will last for 60 minutes.
3. 3. Press  or  to exit HOLD mode manually.

### Show and Set Time of Day

Setting the time is important for filtration settings and other background settings to function as expected. To set the time:

1. 1. Firmly press and hold Menu Select  several times until "TIME" displays on the display.
2. 2. Press the  or  keys to select the hour. Once you have selected the correct hour, press the  key to move to the minute selection.
3. 3. Press the  and  keys to select the minutes. Press  to confirm your selections and exit the Time selection menu.







### Selecting 12, or 24 hour clock

Press  several times until "PREF" displays on the display. Press the  or  button to enter the Preferences Menu. "F/C" will display on the display. Press the  button until "24-12" displays on the display. Press  or  to enter the Time Selection Menu. Select your preferred time clock setting. Press

 to return to the Preferences Menu.



## Temperature and Temp Range

### Adjusting the Set Temperature

Pressing the  and  buttons (Temperature buttons) will cause the temperature to flash. Pressing the  or  button again will adjust the set temperature. Holding the  or  button will cause the temperature to change until the button is released. When the desired temperature is reached, press  to confirm your setting. When the LCD stops flashing, the spa will heat to the selected temperature.

## Dual Temperature Range (High vs. Low)





This system incorporates two temperature range settings with independently set temperatures. To select a range:

1. 1. Press  several times until "TEMP" is visible in the display window. "RANGE" will flash in the bottom right of the screen with an up or down arrow to indicate which selection is currently active. The most common use for the low range is during vacations or extended periods of non-use.
2. 2. Press the  or  buttons to switch between High and Low. When a range is chosen, the spa will heat to the set temperature associated with that range and hold. High Range can be set between 80°F and 104°F. Low Range can be set between 50°F and 99°F. Freeze Protection is active in either range.

### Heat Mode – Ready vs. Rest

When in "Ready" mode, the pump that circulates water through the heater will turn on every 1/2 hour to measure water temperature, heat if needed, and refresh the temperature display. When in Ready mode your spa will continually maintain its set temperature. REST mode is recommended for most economic performance.



### To Set Heat Mode (Ready or Rest)

Press  several times, until "MODE" appears in the display window. Press . The selected mode will flash at the bottom left of the display screen. Press  or  to change the selected heat mode. Press  to confirm your selection.

### Ready-in-Rest Mode

When the spa is in Rest mode and a "Jet" button is manually pressed, the spa will enter Ready-in-Rest mode and heat up to the selected temperature, allowing for use in periods outside of scheduled filter cycles.







## Flip Display







To flip the display, press  until the display reads "FLIP." Press the  or  key. This will invert the display.

# Restricting Operation



The control panel can be restricted to prevent unwanted use or temperature adjustments. This lock feature prevents most functions on the controller from being used, while all automatic functions remain active. "TEMP" locks the temperature selection, preventing unwanted temperature adjustments. "PNL" in contrast, locks all changes from the panel. Features will function as selected.

## To Lock Temperature or Panel

To lock the settings, press  several times until "LOCK" is displayed. Press  or  to select the lock menu. "TEMP" will display in the display window. Press , "OFF" will display in the window. Press , or  to select "ON." Press  to confirm your selection. This will lock the temperature settings. Follow the same process, and select "OFF" to turn off the lock function.

To lock the panel, press  several times until "LOCK" is displayed. Press  to select the lock menu. "TEMP" will display. Next press  and "PNL" will display in the window. Press , "OFF" will flash in the display window. Press  or  to change the setting to "ON." Press  to confirm the panel lock.

## To Unlock Temperature or Panel

Press and hold  and  simultaneously twice for about a second each time. "UNLK" will display in the window and the temperature or panel controls will return to normal.

**NOTE:** If both "PNL" and "TEMP" are locked, the unlock procedure must be performed twice.

# Filtration Cycles

Your R-Series Spa comes factory programmed to run two cycles in each 24 hour period.



**Filter Cycle 1:** Begins at 6:00pm (18:00) and runs for 2 hours for single pump spas and 3 hours for dual pump spas.



**Filter Cycle 2:** Begins at 8:00am (8:00) and runs for 1 hour for both single pump and dual pump spas.



These factory set filtration cycles should be adequate for light to normal spa use (spas used once to twice per week). For cases of more frequent, to heavy spa usage, you may need to increase the filter cycle durations to maintain water clarity.



# Changing Filter Cycles:

## To change filter 1 cycle:

1. Press "MENU SELECT"  button several times until "FLTR1" appears on the display.
2. Press  button, "BEGN" will appear. This indicates Filter Cycle 1's "begin time."
3. Press  button again. The hour digit will flash. Press

 button or  button to adjust hour. (NOTE: "A" for am or "P" for pm will be displayed in the bottom right corner of the display window).





4. Press  button. Minutes will be flash. Press  button or  button to adjust duration of the pump cycle in 15 minute increments.



5. Press  button to save your selection. "RUN HRS" will appear. Press  button to display Filter 1("F1") end time. Push  button to go to Filter 2.



## To change filter 2 cycle:

1. Press  button several times until "FLTR2" appears.

2. Press  button to toggle between "ON" and "OFF" (NOTE: Filter 2 cycle can be turned off. However, this is not recommended and can lead to poor water clarity).

3. Press  button. "BEGN" will appear. Press  button, hour will begin to flash. Press  button or  button to adjust the starting time for Filter 2 filtration. (NOTE: "A" for am or "P" for pm will be displayed in the bottom right corner of the display window).



4. Press  button. Minutes will begin to flash. Press  button or  button to adjust duration of the pump cycle in 15 minute increments.

5. Press  button to save your selection. "RUN HRS" will appear. Press  button to display Filter 2 (F2) end time. Press  button.







"LITE TIMR" is not functional in R-Series Spas.

# To Change Preferences







## Changing temp display between Fahrenheit (F) and Celcius (C)

Press  several times until "PREF" appears in the display window. Press , "F/C" will appear. Press  to confirm your changes.

## Changing 12 or 24 hour clock

Press  several times until "PREF" appears in the display window. Press , "F/C" will appear. Press , "24-12" will display in window. Press , the current selection will flash. Press  until the desired setting is selected. Press  to confirm your selection.

## Turning reminders OFF or ON

Press  several times until "PREF" appears in the display window. Press , "F/C" will appear. Press  several times until "RE-MIN-DERS" begins to scroll through the display. Press , the current selection will begin to flash in the window. Press , to change to your desired selection. Press  to confirm your selection.

## Set Cleanup Cycle

The cleanup cycle, is a maintenance cycle designed provide additional circulation and filtration between regular filter cycles. It runs 30 minutes after each spa use.

## To adjust the duration of the cleanup cycle:

Press **[⏏]** several times until “PREF” appears in the display window. Press **[⏏]**, “F/C” will appear. Press **[⏏]** several times until “CLN—UP” displays in the window. Press **[⏏]**, the current duration of the cycle will begin to flash in the window. Choose a duration time from 0.0 hours to 4.0 hours, by pressing **[⏏]** or **[⏏]** until the desired time displays in the window. Press **[⏏]** to confirm your selection.

**NOTE:** The Preferences Menu may list “DOL-PHIN” as an option. However this function is not used in R-Series spas.

### Stereo Controls (Optional)

If your spa is equipped with an “Elite” Audio system, refer to its separate manual for operating instructions. If your spa has a “Life” Audio system, the spa’s R600 control pad turn the audio system’s Bluetooth function On and Off.

The first time you use your Bluetooth device with a Life Audio system you must first “pair” your device to the spa audio system. Each device must be paired separately.

Turn on your Bluetooth device and place within 20 feet (6 meters) of your spa. The device must have “line of sight” to the spa control panel / equipment door area.

**NOTE:** Certain house construction materials and other obstructions can impair Bluetooth connectivity. You may need to experiment with where to place your BT device for best results.

### To turn on Bluetooth

Press **[⏏]** several times until “BT” appears in the display window. Press **[⏏]** to activate Bluetooth. After approximately 15-20 seconds, “PPGME60” will appear in the Bluetooth list of your electronic device. Select “PPGME60” from the list to connect and “pair” your device to the Life Audio system. After a few seconds the pairing will complete and audio from your device will start playing on the spa audio system. Your Bluetooth devices need only be paired the first time you use a new device. After that your device will connect automatically.





# X SERIES SPA CONTROL PANELS

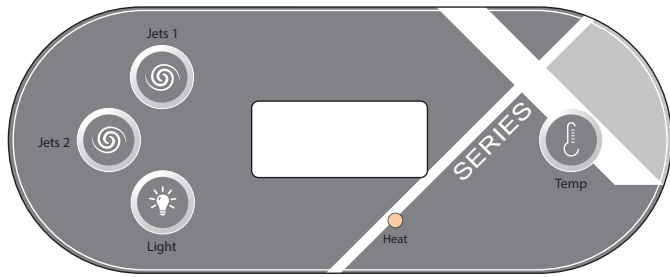

Your spa is pre-programmed with default filter cycles and temperature settings. The following control panel instructions will detail the procedures to alter such default settings.

## Select and Basic Control Systems

### General

Some functions require pressing multiple buttons on the control pad in a certain sequence. This is indicated by a “+” sign in the instruction (for example: press temp + light to enter mode programming). Do not press the buttons at the same time or too quickly, or the desired result may not occur.

### Initial Startup

Before turning on the power to the spa, make sure the spa is properly filled with water. When your spa is first powered up, it will automatically go into “Priming mode”, Press the “Jets 1” button once to start Pump 1 in low-speed and then again to switch to high-speed. Next, if your spa is equipped with a second pump press the Jets 2 or “Aux” button, to turn it on. The pumps will now be running in high-speed to facilitate priming. Once the filter pump has been running for at least 2 minutes, the actual water temperature will be displayed.

**NOTE:** Any time the spa filter pump has not been running for a period of time, the LCD display will usually read “--”, which means the temperature is unknown because the temperature sensors in the heating unit require the water to be circulating past them for a couple minutes before calculating a true water temperature reading.

### Setting the Temperature: 80°F-104°F (26°C-40°C)

Unless changed by the user, the default set temperature from the factory is 100°F (38°C). To change the spa water temperature, press “Temp” once to display the current set temperature it will flash, then press “Temp” additional times to increase (or decrease) the set temperature. To change the temperature adjustment direction (from increase to decrease), pause 5 seconds between pressing “Temp,” then push “Temp” again to desired temperature. After 3 seconds, the LCD will again display the current spa water temperature.

## Spa Operating Modes

A multi-button sequence is used to switch between Standard, Economy, and Sleep modes. Press temp + light buttons repeatedly to cycle through modes.

**Standard Mode (St):** When in Standard mode, the pump that circulates water through the heater (heat pump) will turn on every 1/2 hour to measure water temperature, heat if needed, and refresh the temperature display. To place your spa in Standard mode, press temp + light repeatedly until “St” displays on the screen.

**Economy Mode (Ec):** When in economy mode the spa only circulates and heats water during designated filter cycles. As a result, in the time period between filtration cycles the control may not display the correct water temperature unless the heater pump is on and has been running for up to two minutes. When in Economy mode your spa will heat to its set temperature twice per day during programmed filter cycles. To place your spa in Economy mode, press temp + light repeatedly until “Ec” displays on the screen.

**NOTE:** Spa owners using “Economy Mode” which heats only during filtration cycles, may choose to change to “Standard” mode while using the spa. This will enable the spa to heat and better maintain temperature during spa use. Spa can be changed back to “Economy Mode” when exiting the spa.

**Sleep Mode:** heats the spa to within 20°F/10°C of the set temperature only during filter cycles. This mode is most commonly used during long periods of non-use. To place your spa in Sleep mode, press temp + light repeatedly until “SL” displays on the screen.

Since it takes several hours to bring the spa water back up to set temperature for comfortable use, Sleep Mode is only recommended if the spa will not be used for 2-3 weeks or more.

### Jets 1

Press “Jets 1” to turn pump 1 on and off. If left running, the pump will automatically turn off after 30 minutes.

### Jets 2 (optional)

If your spa is equipped with a two jet pump system, press “Jets 2” to turn pump 2 on or off. If left running, the pump will turn off automatically after 30 minutes.

### LED Lights

Press 1 “Light” button to turn the LED lights on and off. To toggle between all the LED color options, press the light button on, then off, then wait about 1 second and turn on again. A different color option will appear\*. The LED light will turn off automatically after 1 hour.

## Color options:

Each time the light is turned on and off it will advance according to the following sequence:

1. Color wheel: Color changes quickly through available solid colors.
2. Color fade: Colors fade through spectrum A colors.
3. Random Color Change: Random color changes occur in quick succession.
4. Spectrum fade: Colors fade through spectrum B colors.
5. Solid Color: Red
6. Solid Color: Green
7. Solid Color: Blue
8. Solid Color: Yellow
9. Solid Color: Indigo
10. Solid Color: Orange
11. Solid Color: Violet
12. Solid Color: White

## Preset Filter Cycles

There are two filter cycles per day. The first filter cycle begins 6 minutes after the spa is powered up. The second filter cycle begins 12 hours after the start of the first cycle.

The filtration pump will run during filtration cycles. If you spa is equipped with more than one pump, the additional pumps will run for the first few minutes of each filter cycle to purge the plumbing. The factory filter cycle duration is 2 hours. Filter duration can be set to 2, 4, 6, or 8 hours. Continuous filtration can also be selected (indicated by "FC").

To program filter duration, press "Temp" + "Jets 1." Press "Temp" to adjust\*. Press "Jets 1" to exit programming. \*F2= 2 hour filtration, twice per day, F4= 4 hour filtration, twice per day, Etc.

**NOTE:** Allowing the filter pump to operate for extended periods of time with the cover on the spa will result in a rise of the spa water temperature. During warmer months of the year, it is advisable to set the duration of the filtration cycle to the minimum level needed to keep the water clean.

## Freeze Protection

If the temperature drops to 44°F (7°C) within the heater, the pump(s) automatically activates to provide freeze protection. The pump will stay on 4 minutes after the sensor has detected the temperature has reached 45°F (7°C) or higher.

## Ozone Purifier

The optional ozone purifier runs during filter cycles and whenever the spa is heating.



# JETPAKS & JETS

## Interchanging JetPaks- A Series, R Series, and STIL

**Step 1:** Put the spa in “Hold”, this will prevent the pump(s) from activating (see Control Systems).

**Step 2:** Remove the head rest and Snap-Cap by lifting upwards.



**CAUTION!** WHILE PERFORMING STEPS 3&4 YOU MUST USE THE BLACK MANIFOLD AREA AS THE POINT OF CONTACT AS SHOWN IN THE PICTURE. PRESSURE APPLIED TO THE FRONT FACE (ACRYLIC PLATE) MAY CAUSE DAMAGE TO THE JETPAK VOIDING THE WARRANTY

**Step 3:** While applying pressure downward on the manifold push the manifold away from you toward the inside of the spa to release the manifold from the wall clip assembly, then lift the plate straight up to remove.



**Step 4:** Exchange JetPak

**Step 5:** Lower the manifold of the new JetPak carefully as to align the lower valve assembly and gasket into the bulkhead fitting. Apply pressure downward as you pull the JetPak manifold toward you to until the manifold is secured in the wall clip assembly .



**Step 6:** Reattach the Snap-Cap and head rest.

## Jets

### Jet Types

A unique combination of the finest jets available are chosen to optimally balance each JetPak with ideal performance and massage intensity. You can achieve virtually limitless therapy options by adjusting many of the jets for a custom experience.

### Adjustable Jets A, R & S Series

To adjust the water flow to A, R & S Series JetPaks, turn the valve located in the lower portion of each JetPak.

- To increase jet water pressure, turn the valve handle counter clockwise
- To decrease jet water pressure, turn the valve handle clockwise To adjust the water flow to A, R & S Series jets in the shell, turn the inner jet face.
- To increase jet water pressure, turn the jet face clockwise
- To decrease jet water pressure, turn the jet face counter clockwise



### Adjustable Jets X Series Spas

To adjust the water flow on adjustable jets, simply turn the outer ring.

- To increase jet water pressure, turn the outer ring clockwise
- To decrease jet water pressure, turn the outer ring counter clockwise

**NOTE:** Turning off jets will increase pressure to other jets on



same pump. To avoid unnecessary system pressure never shut off all jets at the same time.

**NOTE:** To allow for proper circulation, the valve located in A, R & S Series JetPaks is designed to adjust jet pressure, but will not completely stop jet flow.



# WATER CARE & CHEMISTRY

## Chemicals

Properly maintaining your spa water is very important to ensure enjoyment in using your spa and to maximize spa shell and equipment life. Maintaining your spa water chemistry will require regular attention to prevent poor water quality, potential unhealthy conditions, and possible damage to your spa.

For specific help in maintaining water quality, consult your Authorized Bullfrog Spa dealer who can recommend the correct products and procedures for sanitizing and maintaining your spa.

### CAUTION:

- Always follow chemical manufacturers' instructions and never mix chemicals.
- Use an accurate test kit to perform all chemical tests.
- Add chemicals directly to the spa, evenly spreading the chemicals over the surface of the water with the jets operating, or use an appropriate feeding or metering device and check chemical levels often.
- Run the filter pump on high speed for at least 15 minutes after applying any chemicals.
- Names of spa chemicals will vary from one manufacturer to another. Please contact your authorized Bullfrog Spas dealer if you have any questions.

## Starting the Spa with New Water

**IMPORTANT:** Never fill the spa with soft water unless an appropriate mineral supplement is immediately added. If your water is extremely hard, it is preferable to either dilute the water's hardness by blending the water with water from a water softener, or by the addition of a special water softening chemical. For more information, contact your authorized Bullfrog Spa dealer.

**Step 1:** Add the prescribed dose of Stain and Scale Inhibitor while filling the spa. This will provide the initial protection against staining and scaling. Once the spa is filled, add the prescribed dose of Water Clarifier. This will clear the water of any micro-particulates that may be in the new water.

**Step 2:** If possible, have your authorized Bullfrog Spas dealer test the Calcium Hardness (CH) of your spa. Adjust as per your dealer's recommendations.

**Step 3:** Test and adjust the Total Alkalinity (TA). The TA should measure 125 to 150 parts per million (PPM).

**Step 4:** Test and adjust the pH. The pH should measure 7.4 to 7.6.

**Step 5:** If you use water clarifier. After the spa water has circulated for one hour, add ½ teaspoons of Granular Chlorine or 1 teaspoon of Granular Bromine per each 200 gallons (909.2l) of spa water.

After several hours, check sanitizer level and adjust, if necessary, to the following levels: Chlorine Level:

5.0 PPM (parts per million) Bromine Level: 6.0 PPM (parts per million)

**Step 6:** Startup water chemistry is now complete. However, it may take additional time for the filter to completely clear the water.

## Regular Spa Water Care

### Sanitizer and pH Levels

It is important to test and adjust the sanitizer and pH level of your spa on a frequent basis. If the spa is used 0-3 times weekly, we recommend that you test the water a minimum of 2-3 times a week. For each additional use, test the water one additional time. Test kits and supplies are available from your authorized Bullfrog dealer.

**pH Control:** Proper pH balance is extremely important in controlling bacteria, providing water that is comfortable to the user, and preventing damage to the spa and equipment. The pH scale ranges from 0-14. Levels of pH less than 7.0 are acidic while pH levels greater than 7.0 are basic. The proper pH range for a spa is 7.4-7.6.

**High pH levels (greater than 7.6):** Can cause scale build-up on the spa and its equipment, cloudy water, a prematurely dirty filter, and less effective chlorine sanitation. To correct high pH levels, add a pH decreaser.

**NOTE:** Never use Muriatic or Hydrochloric acid to adjust pH as it can damage the spa shell and surroundings.

**Low pH levels (less than 7.4):** Can cause discomfort to the spa users and corrosion to the spa equipment. To increase pH levels, add a pH increaser.

**Always test, and adjust the pH level before you test and adjust the sanitizer level.**

**Sanitation:** Spa water sanitizers kill bacteria and keep the water clean. Effective and safe sanitizers recommended by Bullfrog Spas are Granular Chlorine (Dichlor) or Granular Bromine. Chlorine and Bromine are the only two spa sanitizers approved for use in spas by the EPA.

**WARNING:** Trichlor Chlorine tablets should never be used in a portable spa. Dissolve rate, potency and the extreme low pH of this chemical can cause severe damage to the spa surface and components. Use of Trichlor Chlorine tablets will void the Bullfrog Warranty.

Bromine and Dichlor tablets are also not recommended as an acceptable sanitizer in Bullfrog Spas unless an appropriate feeding or metering device is used and the water is frequently tested and monitored as excessive Bromine or Chlorine in the spa can cause surface damage and component failure.



With each sanitizer test, use either granular Chlorine or Bromine to maintain the following levels:

- Chlorine Level: 3.0 to 5.0 PPM (parts per million)
- Bromine Level: 3.0 to 6.0 PPM (parts per million)

## Super Sanitation or Spa Shock

Normal sanitation does not eliminate non-filterable wastes, such as perspiration, oils, hair sprays, etc., which will build up in the water. These substances make the water unattractive in appearance, odor, and can interfere with sanitizer effectiveness. Super sanitation is achieved by “shocking” the spa water with a non-Chlorine shock (Potassium Peroxymonosulfate), granular Chlorine (Dichlor), or granular Bromine (Bromine concentrate).

### Super Sanitize the water once a week by adding one of the following:

- Granular Chlorine 2 teaspoons (10ml) of per 200 gallons (909.2l) of water
- Granular Bromine 4 teaspoons (20ml) of per 200 gallons (909.2l) of water
- Non-Chlorine Shock 5 teaspoons (25ml) of per 200 gallons (909.2l) of water

**NOTE:** Super Sanitation may be required more than once per week for heavy usage. With ozone, it may not be necessary to shock the water on a weekly basis, contact your authorized Bullfrog Spas dealer for more information.

**Total Alkalinity (TA):** Total alkalinity (TA) is the quantitative measure ment of alkaline components (carbonates and bicarbonates) present in water to act as a buffer against rapid pH changes. Proper total alkalinity levels are important to ensure optimal chemical balance in spas. Low TA can cause pH to be unstable. To correct low TA, add a Total Alkalinity Increaser. High TA can cause the water to be scale forming, cloudy and corrosive to the spa and its components, as well as other pH related problems. If the spa water has high TA, contact your authorized Bullfrog Spas dealer.

**Calcium Hardness (CH):** Calcium Hardness (CH) is the measure of dissolved calcium in the water. Low CH (soft water) can stain the spa surface as well as cause corrosion to the spa and its equipment. To correct low CH, add a Calcium Hardness

Increaser. High CH (hard water) can cause cloudy water as well as rough scale build-up on the spa surface and equipment. If the spa water has high CH, contact your authorized Bullfrog Spas dealer.

**Stain and Scale Control:** Stain and scale problems are common in hot water environments. To help prevent and control staining and scaling, use a Stain and Scale Inhibitor per the manufacturer’s instructions. Add Stain and Scale Inhibitor 3-4 days after Super Sanitation.

**Foam Control:** Spa water that is polluted with body oils, lotions and soap residue combined with high water temperatures can cause excessive foaming on the water’s surface. For a temporary fix add a Foam Remover as per the manufacturer’s instructions. The best way to control foam is to super chlorinate the water; this will destroy the soap agents that normal levels of sanitizer will not. Add 2 tablespoons (20 ml) per 100 gallons ( 454.6 l).

**Cloudy Water Prevention and Control:** There are two basic reasons that spa water becomes cloudy. First, non-filterable liquid waste (e.g. perspiration) has contaminated the water. To remove these substances, Super Sanitize the water. Second, non-filterable micro-particulate waste (e.g. dust) has contaminated the water. To remove these substances use a Water Clarifier as per the manufacturer’s instructions.

## Water Chemistry Troubleshooting

Prior to each spa use, check the water. If the water appears cloudy, off color, has significant surface foam, or smells of excessive chlorine/bromine, the water needs to be treated or drained. Using the spa in these conditions could result in a skin rash or other irritations.

For assistance in handling spa water chemistry, contact your authorized Bullfrog Spas dealer or another service center capable of performing a computerized water analysis.

# SPA MAINTENANCE

**WARNING:** An empty spa (spa without water in it) must not be left exposed to sunlight as shell damage may occur. Once the spa is unwrapped, fill spa with water immediately or shade the spa with cover or wrapping to prevent direct exposure to sunlight.

## Changing Spa Water

As you use your spa, soap and detergent residues from your skin and bathing suits, along with other substances from maintaining the spa's water chemistry will accumulate in the spa water and make maintaining the water more difficult. Rinsing your bathing suits and showering without soap prior to entering your spa will increase the life of your spa water. Depending upon usage, the spa water will need to be changed every 1-4 months or when the water chemical levels become difficult to manage. When changing spa water, remove all JetPaks®. Clean the shell and JetPod™ areas with a spa surface cleaner. See Spa Shell Care. Clean the other areas of the spa, including JetPaks, with a spa surface cleaner as necessary.

**IMPORTANT:** Drain your spa to an area that can handle a large quantity of water. If draining water onto vegetation, make sure that the sanitizer level (Chlorine or Bromine) of the water is less than 0.5 PPM.

**WARNING:** Avoid drainage that can lead into basement window wells or any other area where damage could occur.

## To Drain Your Spa :

**Step 1:** Turn-off main electrical breaker to spa.

**Step 2:** Locate drain below equipment compartment door.



**Step 3:** Pull the drain out with a slight clockwise turn. Use pliers if needed.

**NOTE:** Drain is fully extended at approximately 2 inches (5 centimeters).

**Step 4:** Remove drain cap.



**NOTE:** The drain spout will not drain when fully extended.

**Step 5:** Attach a standard garden hose. Push the drain spout in halfway to actuate the drain.



**NOTE:** The Spa will drain about 5 gallons (20 liters) per minute. Ensure that the drainage is in an area safely away from window wells or basement entries.

**Step 6:** Once the spa is fully drained, pull the drain spout out all the way, remove hose, replace the drain cap and push drain in all the way.

## To Refill Your Spa:

**WARNING:** When refilling the spa, always Super Sanitize the new water by adhering to the instructions in the Water Chemistry section.

**Step 1:** To avoid air pockets in the pump(s) remove the spa filter(s) and, refill the spa with water by placing the hose into the filter compartment. Fill to the water level indication on the faceplate of the filter assembly.

**Step 2:** Restore electrical power supply.

**Step 3:** Press any button to reset the control system.

**Step 4:** Following instructions for your spa controller type.

## Filter Maintenance

It is recommended that pleated filter cartridge(s) be cleaned every 3-6 weeks or as needed. Spas equipped with the optional circulation pump system may require increased cleaning intervals based on use and local water conditions.

## Replace the filter cartridge(s)

After multiple cleanings, worn filter cartridges will need to be replaced. To maintain warranty protection, use only genuine Bullfrog Spas Filter Cartridge replacements. To clean or replace your filter cartridge(s), complete the following:

**CAUTION:** Never operate spa with the filter(s) removed.

**Step 1:** Place the spa in hold mode.

**Step 2:** Remove Filter SnapCap™ and filter plate. (A Series, R Series, or STIL), or turn the main power off to the spa (X Series).



**Step 3:** Remove cartridge(s) by turning counter clockwise.



**Step 4:** Using a garden hose with a nozzle or other high-pressure device, clean cartridge(s). Work top to bottom on each pleat.



- To remove collected lotions or body oils, soak cartridge(s) in warm water with a Filter Cleaner or detergent.
- To remove calcium deposits, soak cartridge(s) in a plastic container using a 1:10 ratio of Muriatic acid to water solution. Calcium deposits indicate a high spa pH, which should be corrected.

**NOTE:** Filter(s) must be cleaned with a filter cleaner/degreaser before attempting to remove calcium and mineral deposits with any acidic based product

**Step 5:** Reinstall cartridges, filter plate, and Filter SnapCap.

**Step 6:** Press any button to return the control system to normal operation (A Series, R Series or STIL) or restore the main power to the spa (X Series).

**IMPORTANT:** Using a brush to clean a filter cartridge could cause damage to the filter media.

## LED Light Replacement

Contact your authorized Bullfrog Spas Dealer for repair.

## Spa Shell Care

The spa cover is an essential part of the spa system. It will both

protect the spa and to provide the highest possible efficiency. To ensure you have the best experience possible, ensure the cover is in place except during spa use. The best protection for your comes when the cover is on the spa with the skirt covering the entire shell.

## General Cleaning

For normal cleaning, use a mild dishwashing soap, window cleaner, or other products recommended by your local authorized Bullfrog Spas Dealer. For stubborn stains, use a mild acrylic cleaner or a mild detergent. To apply these cleaners, use a soft, damp cloth or sponge. Rinse well and dry with a clean cloth. To clean hard water stains, remove light scratches and protect your spa shell, contact your authorized Bullfrog Spas Dealer.

## Cleaning the Scum Line

With normal use of the spa, oils, lotions, and hair products will build up on the surface of the water. This will leave a scum line around the perimeter. This can be easily removed using a spa surface cleaner or its equivalent. Avoid using cleaning agents that leave soap residue in the water.

**WARNING:** Never allow your spa surface to be exposed to alcohol, acetone (nail polish remover), nail polish, dry cleaning solution, lacquer thinners, gasoline, pine oil, abrasive cleaners, or any other household chemicals other than those listed. These chemicals void the warranty.

## Special Care For R Series Injection Molded JetPaks

High levels of sanitizer and normal use over time can have a bleaching effect on the injection molded (dark gray) Jetpaks. These can be cleaned / buffed to look like new again with the aid of automotive polishing compound found at any automotive retailer. Simply use a soft towel to rub this compound onto the plastic. Then buff with a dry towel.

## JetPak™ Plumbing Care

For optimum spa care, each time the spa water is changed, remove all JetPaks. Clean the back manifold area on with a spa surface cleaner and a long, soft bristle brush. For cleaning the JetPak acrylic surface, refer to Spa Shell Care.

## Spa Cabinet Care

The EternaWood™ cabinet components are made to provide many years of maintenance-free service. For normal cleaning, use a mild dishwashing soap. For stubborn stains, contact your authorized Bullfrog Spas Dealer.

## Spa Cover Care

Your spa cover is warranted by its manufacturer. Although basic instructions are provided below, it is important that you refer to the information that came with the cover. The manufacturer provides detailed information on caring for your spa cover and what to do to protect its warranty.

**WARNING:** A non-secured, improperly secured, or damaged cover may pose a safety threat to children and



may also cause damage or injury if blown off by wind. Always remove entire cover before using the spa.

**IMPORTANT:** Do not stand, sit, or place any item on the cover that could damage it. Gently remove any snow accumulations over 2 inches (5cm). Always secure the cover with all of the cover locks when not in use, whether the spa is empty or full of water.

## Cleaning the Spa Cover

**At least monthly, clean the spa cover.**

**Step 1:** Remove the cover and lay it down on a flat, clean surface near a garden hose.

**Step 2:** Rinse the cover to remove any loose debris.

**Step 3:** Clean the top (vinyl) of the cover with a mild solution of dishwashing soap, or other cleaner recommended by your local authorized Bullfrog Spas Dealer. Apply cleaner with a soft bristle brush. Using a gentle circular motion, scrub the cover, being careful to not let any of the cover dry before rinsing with water.

**Step 4:** Rinse the cover thoroughly and dry with a clean cloth.

**Step 5:** Use a spa cover protectant (never a petroleum-based product) to condition the cover per your Bullfrog Spas dealer's instructions.

**Step 6:** Wipe and rinse any dirt from the bottom of the cover.

**Step 7:** Replace the cover and secure the locks.

**NOTE:** To remove tree sap, use lighter fluid (the type used in cigarette lighters). Use sparingly. Immediately apply a spa cover protectant to the area.

## Miscellaneous Care

### Cleaning and Protecting the Pillows

Regularly clean all pillows with mild soap, water, and a clean cloth. Monthly, treat pillows using a non-petroleum-based conditioning product as recommended by your Bullfrog Spas dealer. This will maintain water resistance and luster of the product.

**IMPORTANT:** Remove the pillows when shocking the spa or when sanitizer levels are high. Leave cover open for at least 30 minutes after shocking to ensure pillows are not affected.

**NOTE:** Pillow discoloration is accelerated by high sanitizer use and is not covered by the Bullfrog Spas Warranty.

### Vacuum the Spa

Debris from wind, trees, and users will occasionally accumulate on the bottom of the spa. The filtration system will remove the smaller debris. Large or heavy debris can be removed with a hand held spa vacuum available at your Bullfrog Spas dealer.

## Low-Use or No-Use Periods

During certain times of the year, you may not use the spa on a frequent basis. For these low-use or no-use periods, consider the following:

### No Use for Two to Six Weeks

If the spa will not be used for at least two weeks, lower the temperature to the lowest setting of 80 F (26°C) or place in low range heat mode. Lowering the temperature will cut the cost of operation, however; you will need to adjust the temperature setting approximately 4 hours before use in order to heat the spa to 100 F (38°C).

**IMPORTANT:** During all low and no-use periods, be sure to maintain the spa water as per the instructions in the Water Chemistry section.

**IMPORTANT:** For all no-use periods, and on a weekly basis, be sure to have someone visually check that the spa is functioning correctly and to also maintain the spa water as per the instructions under the Water Chemistry section. Not doing so may lead to corrosion, staining, and/or scaling to the spa and its equipment. During periods of freezing temperatures, a spa that has malfunctioned may be subject to damaged plumbing or equipment as a result of ice buildup within the spa. If the spa cannot be checked and maintained on a weekly basis, then consider winterizing the spa.

### No Use for Over Six Weeks

When you are not planning to use the spa for six or more weeks, or when someone is not able to maintain the spa on a weekly basis, you should winterize the spa. To winterize, follow these steps:

### Winterization

**WARNING:** Prior to winterizing your spa, it will be necessary to Super Sanitize the spa water as per the instructions in the Water Chemistry section. This procedure will help prevent the growth of bacteria, algae and fungi in any areas of plumbing that may not be fully free of water after you drain your spa for its period of winterization.

**Step 1:** Drain the water.

**Step 2:** If your spa is equipped with JetPaks, open all lower valves to allow the water to drain from each pak as you drain the spa. Once the water is completely out of the spa then close each valve before starting proceeding to step 3.

**Step 3:** Use a wet shop vacuum to vacuum the plumbing lines by placing the vacuum nozzle over each of the lower jet faces in the spa. Lower jets are any at or below the bench seat area

**Step 4:** Remove the drain plug from the pump(s) and loosen all PVC pipe unions in the equipment compartment. Do not replace the plugs or tighten the unions until the spa is de-winterized.

**Step 5:** Clean the spa shell and JetPaks (if equipped).

**Step 6:** Remove filter cartridge(s), clean, and reinstall.



**Step 7:** Secure the cover to the spa utilizing the tie downs and locking system. In areas where heavy snow is anticipated, place a large piece of plywood (or its equivalent) on top of the spa cover to assist in supporting the cover with the added weight of the snow. Remove snow off the cover following each snow storm.

**WARNING:** To avoid water from becoming trapped between the floor suction fitting and the filter pipe. Use a wet/dry vacuum to remove the remaining water out of pipe by placing the vacuum end over the filter hole. In a two-pump spa, first plug off one filter using a tennis ball then vacuum out the water. Or pour ½-1 gallons (5-9 liters) of RV antifreeze into the filter hole.

**NOTE:** RV antifreeze is nontoxic and does not require evacuation at start up.

## Spa De-Winterization

To de-winterize the spa, reverse the winterization procedure. Refill to the water level mark.

**WARNING:** Whenever refilling the spa, it will be necessary to Super Sanitize the new spa water. Instructions are found in the Water Chemistry section.

# Removing the Equipment Door

## STIL Door Removal

The STIL spa is designed so that there are no visible fasteners from the exterior. This is accomplished by using an innovative style of snap features in both the corners and the cabinet panels. If properly removed using these instructions, servicing this spa is easy to do.

**Step 1:** Remove Corners – It is important to remove the front two corners overlapping the door before attempting to remove the door itself. This is done by placing a short flathead screwdriver below the corner and slipping it up partway behind the corner and using it as a lever to pry out the bottom half of the corner outward.

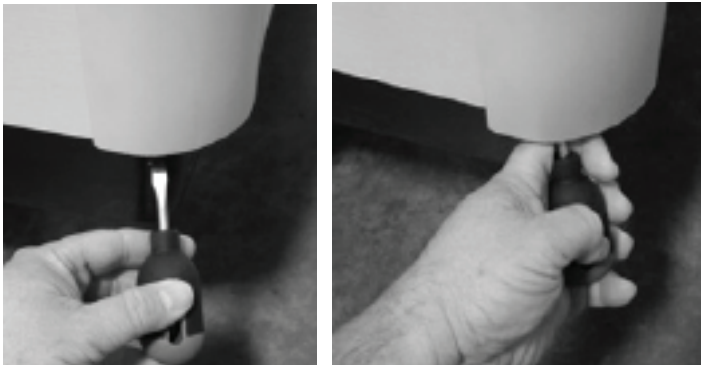

Once this is done, grab the corner by the bottom and pull it straight out allowing the top snap to come free. Pull corner down and out of the groove on the top.

**Step 2:** Remove Door – Once both front corners are removed, look on each side of the front door to see the snap feature built

into the cabinet. To remove the door, start by placing a longer flathead screwdriver or short pry bar into the center of the snap feature and use it as a lever to pop the door out of the first snap. Grab the base of the door and carefully begin pulling it out such that the rest of the snaps come free one by one across the length of the door. The door can then be dropped out of the groove on top and removed from the spa.



**Step 3:** Electrical Disconnect – be sure to disconnect any lighting or any other electrical wiring that is mounted onto the door before completely removing it.

## STIL Door Installation

**Step 1:** Electrical –Reconnect any lighting or electrical devices on the door before installing.

**Step 2:** Door – Slip the upper lip of the door into the top groove of the extrusion. Lower the door while gently pushing on it until you feel the snaps line up with the snap features in the ribs. Starting from one side, force the first snap into place. Continue down the length of the door and forcefully push the cabinet into each of the snaps until the door is completely in and secured. You can feel along the bottom to make sure all are in place and no gaps are present.

**Step 3:** Corner – Slip the upper lip of the corner into the top groove of the spa. Starting from the top force the first snap into place, if the corner has slipped down and is not flush with the top groove this is the best time to push it back up into place. Continue down the length of the corner and forcefully push it into each of the snaps until the corner is completely in secured. The corner should fit tightly against the cabinet on both sides.



## A,R & X Series Door Removal

**Step 1:** Remove hardware - Remove all door mounting bolts (2 or 3 per side) and trim strips.



**Step 2:** Remove door - Carefully pull bottom of door out toward you. Carefully grab the bottom corner of the door and pull it out enough that you can slip your other hand in behind the side of the door about 4-5 inches up from the bottom. From there you will pull the door firmly away from the spa until the snap on the door pulls out of the snap feature in the rib. Continue to pull the door away until the second snap on the other side pulls out. The door can then be dropped out of the groove on top and removed from the spa.



**Step 3:** Electrical Disconnect – be sure to disconnect any lighting or any other electrical wiring that is mounted onto the door before completely removing it.

**Step 4:** When removed, lean door against spa. To reinstall spa door, reverse the instructions above.

## A,R & X Series Door Installation

**Step 1:** Electrical –Reconnect any lighting or electrical devices on the door before installing.

**Step 2:** Door – Slip the upper lip of the door into the top behind the lip of the spa. Lower the door while gently pushing on it until you feel the snaps line up with the snap features in the ribs. Starting from one side, force the first snap into place and then force the other side until the door is secured.

**Step 3:** Hardware - Replace trim strips and mounting bolts.

## X6R Door Removal

**Step 1:** Remove hardware - Remove all door mounting bolts (3 per side) and trim strips.

**Step 2:** Remove door – Pull the bottom of the door forward, the door can then be dropped out of the groove on top and removed from the spa.

**Step 3:** Electrical Disconnect – be sure to disconnect any lighting or any other electrical wiring that is mounted onto the door before completely removing it.

**Step 4:** After the door has been completely removed, lean door against spa.

## X6R Door Installation

**Step 1:** Electrical –Reconnect any lighting or electrical devices on the door before installing.

**Step 2:** Door – Slip the upper lip of the door behind the lip of the spa. Place door securely against spa flush with the side panels.

**Step 3:** Hardware - Replace trim strips and mounting bolts.

## REFERENCE MATERIAL

Before attempting to install or use your spa, please read Important Safety Instructions as well as all the installation instructions that follow.

## Site Selection and Preparation

Your home most likely offers multiple sites where your spa may be installed. Use the information presented in this section to assist you in carefully selecting the site that works best for you. It is your responsibility to choose and prepare the site properly before delivery, so you will experience a smooth and efficient delivery as well as obtain optimal use and full enjoyment of your spa.

## Environment

**Surroundings:** The direction that your spa will be facing will contribute to your overall bathing experience. Select the spa location that will provide optimal views based on your property layout. Consider your lifestyle and where you want to enjoy your spa and situate it accordingly. Indoor installations provide privacy, but create high levels of humidity (see Indoor Considerations). If your spa is outside, a nearby place for you and your guests to change clothes is a huge convenience. Also, a location near a house entry is convenient in areas with extreme winter climates.

## Indoor Considerations: Indoor spa installations have special requirements.

The environment both around and below the spa should be water resistant, and preferably waterproof. It must be capable of handling water splashed out from the spa as well as the possibility of a malfunction.

Recommendations to handle water around the spa include, but are not limited to, a floor drain and/or a catch basin equivalent to the volume of water in your spa. Condensation can also occur on the spa cover and drip onto the floor. Therefore, ensure that flooring materials provide a good grip when wet and are resilient to constant exposure of water and chemicals.

In addition to handling the water from the spa, it is recommended that the room be properly ventilated. Humidity levels will naturally increase after the spa is installed and in use. Water may get into woodwork and produce dry rot, mildew, or other problems. Over time, high levels of humidity and spa chemicals can cause water damage to your floor, wall, and ceiling surfaces.

To minimize humidity damage, it is best to provide plenty of ventilation such as a ceiling fan and moisture-resistant paint. An architect can help to determine if special ventilation equipment is required, such as a humidistat or dehumidifier which can be installed to regulate indoor humidity during spa use.

**NOTE:** Typical indoor surfaces include, but are not limited to concrete, wood, non-slip tile, or linoleum.

**Outdoor Considerations:** There are several considerations when installing your spa outdoors.

1. Avoid selecting a site where excessive water may contact the spa, such as sprinklers or a roof edge without rain gutters.
2. Avoid areas of direct, prolonged sunlight (if possible). The ultraviolet rays may fade or damage the spa cover and cabinet.
3. Check all applicable national and local codes regarding possible restrictions that require fencing or childproof gates around the spa.
4. Prevent dirt, sand, and foliage from being tracked into your spa by utilizing concrete, concrete pavers, or stone for paths and access areas (or, avoid positioning your spa in an area where debris will be tracked into the spa). Check the location of trees and spill paths from gutters to determine if wind or rain will sweep debris into your spa.
5. Consider your view and your privacy during all seasons of the year so your experience in your outdoor spa will be enhanced rather than limited.

**NOTE:** Typical outdoor surfaces include, but are not limited to concrete, brick, non-slip tile, wood decking, pea gravel, or sand.

## Spa Location

**Service Access:** Some people choose to install tile, stone, or custom wood around their spas. If you are installing your spa with custom trimming, remember to allow access for service. Should your spa need service, a technician may need to remove the spa's equipment compartment door or side panels, or access the spa from beneath. Also, it is always best to design special installations so the spa can still be moved, or lifted from the ground.

**Access to Circuit Breakers:** For service purposes, allow easy access to the circuit breakers in the electrical service panel (permanently connected models), or to the interrupter switch on the end of the power cord (cord-connected models).

**Electrical Safety Requirements:** The installation of all spas must be in accordance with national and local wiring rules. A licensed Electrician must perform the electrical installation and

GFCI test procedure. Each Bullfrog Spa is manufactured and tested to a standard that provides maximum protection against electrical shock.

Improper wiring may prevent the spa from operating safely which could result in electrical shock, injury, or death. Improper wiring could also lead to a malfunction of the spa's equipment and risk of fire. When considering a location for your spa, consult with a licensed Electrician pertaining to the following:

**Overhead Power Lines:** Based upon the national and local wiring rules that apply to your area, you will need to install your spa at the required minimum horizontal and vertical distances from all power lines.

**Service Disconnect:** Based upon your area, a disconnect device must be incorporated into the fixed wiring in accordance with national and local wiring rules. If the national and local wiring rules permit, a GFCI or RCD Sub-Panel may be used to substitute the service disconnect, providing that it is located within the same parameters.

**Electrical Outlets, Switches and Devices:** Based upon the national and local wiring rules that apply to your area, you must install your spa at the required minimum distance from all electrical outlets, switches, and devices.

**Bonding:** Based upon the national and local wiring rules that apply to your area, the Control System Box located inside the equipment compartment of your spa must be bonded to all metal equipment, handrails, fixtures, enclosures, pipe, or conduit that are located within the maximum specified distances. The bonding is to be connected to the ground lug connector on the exterior surface of the Control System Box and all metal items previously described.

**Equipment Compartment Access:** Make sure the spa is positioned so access to the equipment compartment will not be blocked.

**All other national and local rules that may be applicable.**

**Water Drainage:** Your spa contains an equipment compartment, which houses all of its electrical components. Allowing water into the equipment compartment can damage the electronics, or may result in tripping your spa's circuit breaker. If installing the spa in a SpaVault, below ground level, or where water may accumulate it is the owner's responsibility to ensure that water will drain adequately so as not to damage spa equipment. For normal installations at ground level choose a site where water will drain away from the spa.

**Use of a Cover-Lifting Mechanism:** If using a cover-lifting mechanism, allow up to 18 inches (.61m) of clearance behind the spa. Check with your authorized Bullfrog Spas Dealer for the exact clearance requirements for the cover-lifting mechanism.



## Spa Foundation

**General Guidelines:** Select a structurally sound flat surface that is reasonably level to serve as your spa's foundation. A foundation that shifts or settles may cause stress to the spa shell.

The foundation that your spa rests on must have a weight bearing load capability of supporting the weight of your spa, its water, and the people using it. The maximum filled weight of a spa can be as much as 6,000 lbs. (2,800kg), plus the weight of the occupants that use the spa (for the weight bearing load requirements as well as the maximum filled weight of your spa, refer to the Spa Technical Specifications Chart or contact your local authorized Bullfrog Spas Dealer).

If your spa's pad is slightly sloped it may not affect the performance of the spa or its structure, however, there should be no dips, sags, or unevenness in the pad. Most patios are built to slope away from the house for drainage purposes. There should be no more than a 1/2" (1cm) slope in an 8 ft (2m) run. Recommended flooring materials include a concrete pad, concrete pavers or bricks, pea gravel, or crushed rock 1.5" (4cm) or less, or a reinforced deck. Additionally, your authorized Bullfrog Spas Dealer may sell or recommend pre-formed spa pads.

**NOTE:** Concrete foundations should be a minimum of 4 inches (10cm) thick and should be reinforced with either rebar or mesh. For electrical grounding purposes, the rebar or mesh should be attached to a bond wire (see Electrical Requirements and Installation Instructions).

**WARNING:** To prevent serious damage to your spa, it is important that the spa foundation be supported by a flat, stable, and consistent subsurface. Bullfrog Spas International highly recommends consulting a qualified, licensed contractor prior to the installation of any spa foundation. For assistance, contact your authorized Bullfrog Spas Dealer.

Obstacles such as overhanging tree limbs, awnings, protruding gas meters, water meters, and A/C units can prevent easy access.

If there are more than six consecutive stairs without a landing then you may be required to find another delivery path.

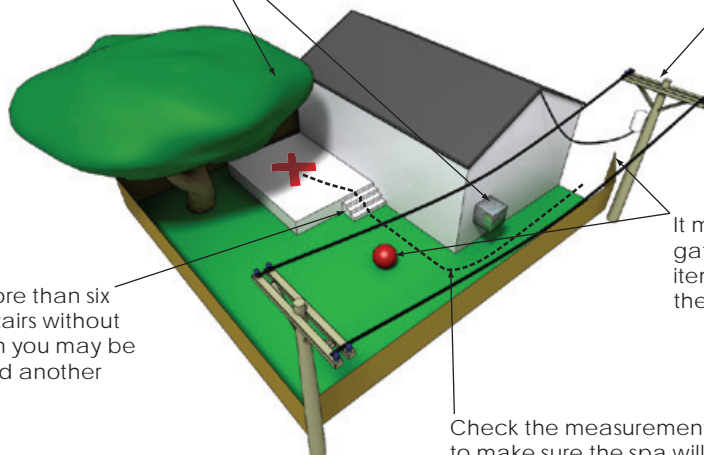

**WARNING:** Because your spa pad must provide continuous support for the entire base of the spa, you should never level it with shims. If it is necessary to level your spa, make sure the entire spa's structure is fully supported, both in the center as well as the outer edge. When leveling your spa, there should be no voids beneath it. Contact your authorized Bullfrog Spas Dealer before making any leveling adjustments. Structural damage to the spa resulting from incorrect installation, placement on an inadequate foundation, or improper leveling will void the spa's warranty.

**Elevated Installations:** Be certain your deck or elevated structure can support the maximum filled weight of your spa along with the total weight of occupants that use it. You must know the deck's weight-bearing load capacity and ensure that it is greater than the maximum filled weight of your spa combined with the occupants using it or serious injury or structural damage could result.

To find the weight bearing load requirement along with the maximum filled weight of your spa, refer to the Spa Technical Specifications Chart or contact an authorized Bullfrog Spas Dealer.

### Concrete Pad

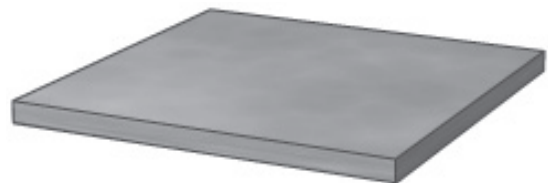

**WARNING:** Watch for power lines.

It may be necessary to remove a gate, part of a fence, or other items in order to dolly the spa to the desired location.

Check the measurements on 90° turns to make sure the spa will fit through.



### Concrete Pavers

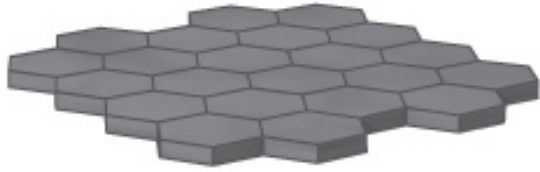

### Pea Gravel or Crushed Rock

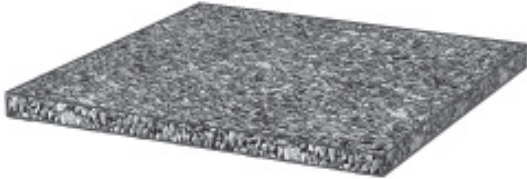

**CAUTION:** Consult a qualified structural engineer or contractor before the spa is placed on an elevated structure or deck.

### Design Considerations

**Hard-Surface Options (Decking and Flooring):** In addition to selecting a hard surface that meets the recommended safety and maintenance criteria, consider textures and colors that will assist in enhancing the aesthetics of the area in which your spa will be installed. The decision to match, contrast, or blend the hard surface colors and textures with those of your spa should only be made after carefully researching your options. The cost of a Landscape Architect may be money well spent.

**Surrounding Landscape:** The correct landscape around your spa will not only soften the adjacent hard surface areas, but will add life and much enjoyment to the environment. If the budget allows, you may want to consult with a Landscape Architect for expert advice.

**Spa-Side Accessories:** Besides selecting the correct hard surfaces and landscape around your spa, the addition of the proper spa-side accessories will provide just the finishing touch

that you are looking for. Spa steps, benches, towel racks, planter boxes, or an outdoor fireplace are just a few of the items that can be considered when accessorizing your spa.

## Delivery Basics

To prepare for the delivery of your spa, make sure the delivery path is clear and no obstructions are present.

Occasionally a crane is required to install the spa by lifting it to its final destination. The crane operator will lift your spa over walls, buildings, or any other obstruction and place it as close to the installation site as possible.

Depending on access to the spa site, your spa may be dollied in either horizontal or vertical position. For your convenience, the following charts provide the dimensions of your spa in either the horizontal or vertical position.

**WARNING:** An empty spa (spa without water in it) must not be left exposed to sunlight as shell damage may occur. Once the spa is unwrapped, fill spa with water immediately or shade the spa with cover or wrapping to prevent direct exposure to sunlight.

**WARNING:** Watch for power lines.

## Spa Dimensions Chart

Model	Width	Length	Height
8ft Series Spas	7'10" (2.39m)	7'10" (2.39m)	38" (.97m)
7ft Series Spas	7'4" (2.24m)	7'4" (2.24m)	36" (.91m)
6ft Series Spas	7'4" (2.24m)	6'8" (2.03m)	34" (.86m)
5ft Series Spas	5'8" (1.73m)	7'0" (2.13m)	31" (.79m)

Corner Radius for A, & R, & X Models is 8" (0.3937m)  
Radius for Stil Models is 2.5" (0.0635m)

# Electrical Chaseways

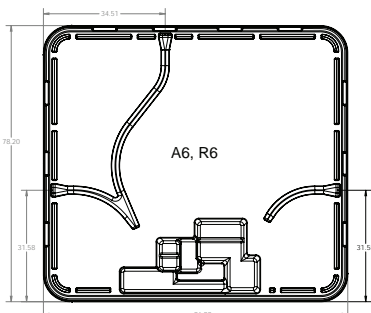
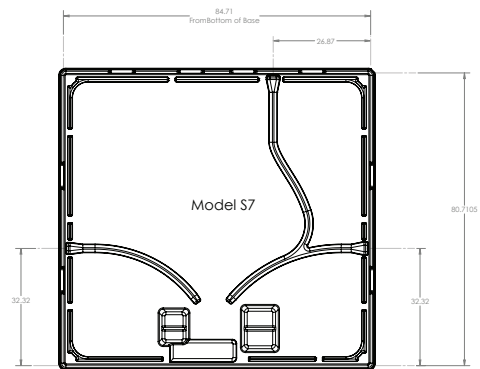
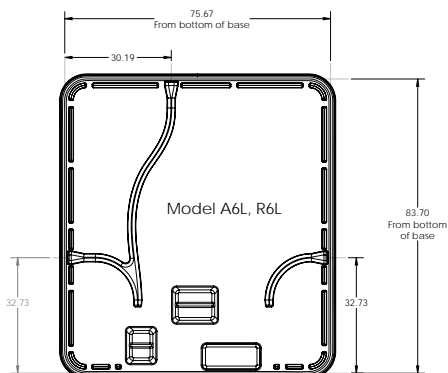
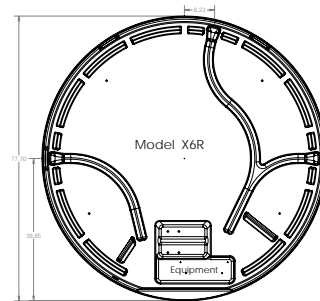
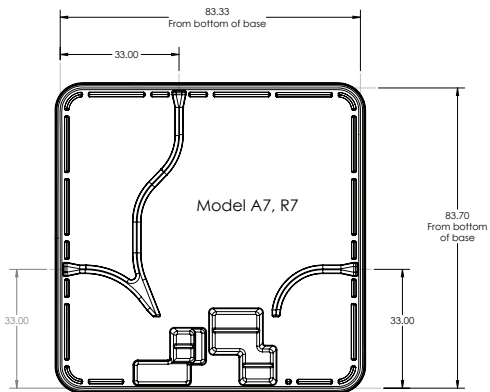
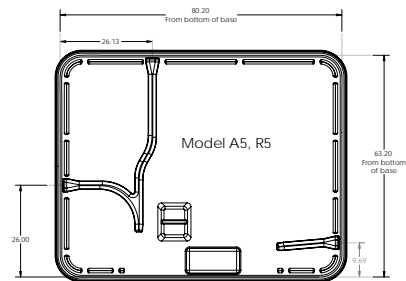
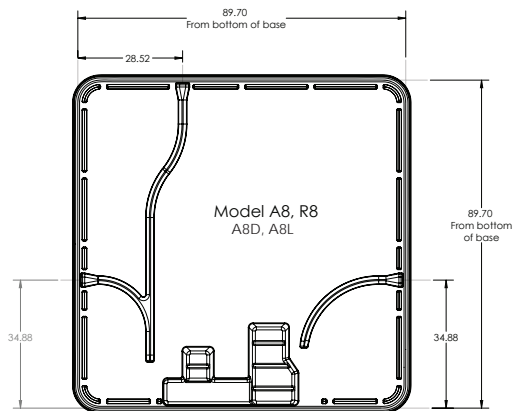

L

# Electrical Requirements & Installation

## Instructions

**IMPORTANT:** Provide a copy of these instructions to your Electrician. The installation of all spas must be in accordance with national and local wiring rules. Always have a licensed Electrician perform the electrical installation. Each Bullfrog Spa is manufactured and tested to a standard that provides maximum protection against electrical shock. Improper wiring may prevent the spa from operating safely which could result in electrical shock, injury or death. Improper wiring could also lead to a malfunction of the spa's equipment and risk of fire.

### Drilling Conduit Hole:

All dimensions are at the bottom base.

1" (2.54cm) Conduit Drill 1-3/8" (3.49cm) hole 3/4" (1.91cm) Conduit Drill 1-1/8" (2.86cm) hole Center of hole is 1" (2.54cm) from the ground

## Important Technical Information

**Voltage Definitions:** When reading these instructions, the term 120V~ refers to the 110-120V~ range of voltage, while the 240V~ term refers to the 220-240 range of voltage.

**Wiring Connection:** Appliance must be permanently connected to fixed wiring (except for U.S./CAN 120V~/60Hz Cord-Connected units).

**Wiring Diagrams:** In addition to the instructions that follow, please reference the appropriate Wiring Diagrams (120V~/60Hz Cord-Connected, 120V~/60Hz Permanently-Connected, 240V~/60Hz Permanently-Connected, or 230V~/50Hz Permanently-Connected).

**Electrical Service Wire Size and Type:** The size of wire required to supply the spa with power is dependent upon the length of the electrical run and should only be determined by a licensed Electrician. Installation must be in accordance with all national and local wiring rules. All wiring must be copper to ensure adequate connections. Never use aluminum wire.

## Spa Location:

**Overhead Power Lines:** Based upon the national and local wiring rules that apply to your area, you will need to install your spa at the required minimum horizontal and vertical distances from all power lines.

**Service Disconnect:** Based upon your area, a disconnect device must be incorporated into the fixed wiring in accordance with national and local wiring rules. If the national and local wiring rules permit, a GFCI Sub Panel may be used to substitute the service disconnect, providing that it is located within the same parameters.

**Electrical Outlets, Switches and Devices:** Based upon

the national and local wiring rules that apply to your area, you must install your spa at or beyond the required minimum distance from all electrical outlets, switches, and devices.

**Bonding:** Based upon the national and local wiring rules that apply to your area, the Control System Box located inside the equipment compartment of your spa must be bonded to all metal equipment, handrails, fixtures, enclosures, pipe, or conduit that are located within the maximum specified distances. The bonding is to be connected to the ground lug connector on the exterior surface of the Control System Box and all metal items previously described.

**Equipment Compartment Access:** Make sure the spa is positioned so that access to the equipment compartment will not be blocked.

### Ground Fault Circuit Interrupters ( GFCI) or

**Residual Current Devices (RCD):** As per national and local wiring rules, all spas, hot tubs, and associated electrical components must be protected by a GFCI or RCD, either at the main breaker box or at the service disconnect.

**WARNING:** Removal or bypassing the GFCI will result in an unsafe spa and will void your spa's warranty. When installing the GFCI, all conductors except the green ground must be routed through the GFCI, including the neutral. Never bypass the neutral line. If the neutral line is bypassed, then the current will be imbalanced and cause the GFCI to trip. See GFCI Wiring Diagrams or contact Bullfrog International, LC or your authorized Bullfrog Spa dealer.

**REQUIRED TEST PROCEDURE:** After the spa is first filled and turned on, and prior to each use, the GFCI should be tested as follows:

**Step 1:** Press test on the GFCI breaker. The spa should stop operating.

**Step 2:** After 30 seconds, press reset and then verify that power has been restored to the spa. If the GFCI fails to operate in this manner you may have an electrical malfunction and be at risk of electrical shock. Should this occur, turn off the GFCI breaker to the spa and do not use the spa until the malfunction has been repaired by a licensed Electrician or your authorized Bullfrog Spa dealer.

**Dedicated Electrical Circuit Breaker:** The electrical service to the spa must include a suitably rated switch or circuit breaker. Whether the spa is a 120V~/60Hz Cord-Connected spa or a 120V~/60Hz, 240V~/60Hz or 230V~/50Hz Permanently-Connected spa, it is required that the circuit breaker that supplies power to the spa is dedicated and does not supply power to any other electrical outlet, device or item.

**Electrical Access Conduit:** Each Bullfrog Spa is manufactured with three electrical access chaseways in its base to allow conduit to be run to the spas control system. These chaseways are marked by stickers indicating access points.

**12V Maximum on Live Parts:** Live parts accessible to the user must not exceed 12V.

**240V~/60Hz 30A Conversion Option:** If there is not 50A of electrical service available, an authorized Bullfrog Spa dealer or Electrician can easily convert the spa to operate on 30A (conversion instructions are located inside the Control System Box). Please be aware, spas converted to 30A are only capable of heating the water when pump 1 is in low-speed, not high-speed. This heating limitation is acceptable in most climates as well as indoor installations.

**230V~/50Hz, 32A Conversion Options:** If there is not 32A of electrical service available, an authorized Bullfrog Spa dealer or an Electrician can easily convert the spa to operate on either a single or dual 16A x2 service. Conversion instructions for the following configurations are located inside the Control System Box of the spa.

**230V~/50Hz 16A Single Service:** Please be aware, spas converted to 16A are only capable of heating the water when the circulation pump is in low-speed, not high-speed. This heating limitation is acceptable in most climates as well as indoor installations.

**230V~/50Hz 16A, 16A Dual Service:** Operation of spa is identical to single 32A service except that service is divided into two separate 16A services.

**400V~3N 16A x 3, 50Hz Service:** Operation of spa is identical to 32A service is divided into 3 separate 240V~ services with one shared neutral.

## New Installations and Re-Installations

These instructions apply to both new installations and re-installations which may occur when a spa is moved or relocated to a new location.

### 120V~/60Hz Equipment

**120V~/60Hz CordConnected Installation:** This option is only applicable if the spa was ordered from the factory with both a 120V~/60Hz pump and a 120V~/60Hz power cord. The spa's Safety Approval Listing and warranty will be void, and the spa may be unsafe if an aftermarket power cord is installed on the spa. Cord-Connected spas have already been converted to operate on 120V~/60Hz power at the factory and come with approximately 15' (4.57m) of useable power cord (the maximum length allowed) attached to the spa. This factory installed power cord comes with a built-in GFCI breaker.

**IMPORTANT:** Cordage shall be replaced only with a special cordage assembly available from the manufacturer, its service agent, or similarly qualified persons in order to avoid a hazard.

Cord-Connected 120V~/60Hz spas require that the factory installed power cord, with its built-in GFCI breaker be connected

to a 120V~/60Hz, 15A, Single-Phase, dedicated, grounded circuit and power outlet. It is important that this circuit is dedicated (not being used by any other electrical appliance) or your spa may not function properly.

For safety purposes, the location of the power outlet (where the spa is to be connected) can be no closer than the minimum allowable distance specified by the national and local wiring rules in your area. Installation must be in accordance with all national and local wiring rules.

**WARNING:** Never use an extension cord. Bullfrog International, LC does not allow the use of an extension cord under any possible situation. The use of an extension cord voids any warranty on the spa equipment and also exposes the consumer to additional risk of fire, electrical shock, injury, or death.

### 120V~/60Hz Equipment

Permanently-Connected 120V~/60Hz spas require a GFCI protected, 3-wire (Line 1, Neutral and Ground), 120V~/60Hz, 15A, Single-Phase, dedicated electrical circuit. It is important that this circuit is dedicated (not being used by any other electrical appliance) or the spa may not function properly. Installation must be in accordance with all national and local wiring rules.

### 240V~/60Hz Equipment

Permanently-Connected 240V~/60Hz spas require a GFCI protected, 4-wire (Line 1, Line 2, Neutral, and Ground), 240V~/60Hz, 50A, Single-Phase, dedicated electrical circuit. It is important that this circuit is dedicated (not being used by any other electrical appliance) or the spa may not function properly. Installation must be in accordance with all national and local wiring rules.

### 230V~/50Hz Equipment

This equipment allows for the spas to operate only on a 230V~/50 Hz electrical service.

Permanently-Connected 230V~/50Hz, 32A spas require an RCD protected, 230V~50Hz, 32A Single-Service, or 16A Single Service, or 16A-16A x2, 400V~,3N, 50Hz, 16Ax3, dedicated electrical circuit. It is important that this circuit is dedicated (not being used by any other electrical appliance) or the spa may not function properly. For specific conversion instruction, please refer to the system wiring diagram inside the Control System Box (located in the spa's equipment compartment). Installation must be in accordance with all national and local wiring rules.



# Connecting the electrical service to the spa

**IMPORTANT:** Installation must be in accordance with all national and local wiring rules and performed by a licensed Electrician.

**Step 1:** Choose one of the three available conduit entry points. (Yellow Black decal)

**Step 2:** Determine the conduit diameter and drill a hole that is properly sized for the conduit ( $\frac{3}{4}$ " conduit drill 1-1/8" hole, 1" conduit drill 1-3/8" hole). Use the + as the locator for the center of the hole. The hole saw must go through two layers of plastic. There is a 1" space between both layers.

**Step 3:** Push the conduit through the hole until it comes out into the equipment area.

**Step 4:** Remove the faceplate to the Control System Box

**Step 5:** Connect the conduit to the Control System Box using a Liquid Tight Connector.

**Step 6:** Run the required wires through the conduit to the Control System Box.

**Step 7:** Connect the electrical service wires to the terminal block located in the Control System Box.

**Step 8:** Replace the Control System Box faceplate and the equipment compartment door. The electrical hook-up is complete.

**Note:** To conform with electrical codes, and to create a barrier against pests, any holes created in the base of your Bullfrog Spa should be fitted with an appropriate connector.

# GFCI WIRING DIAGRAMS

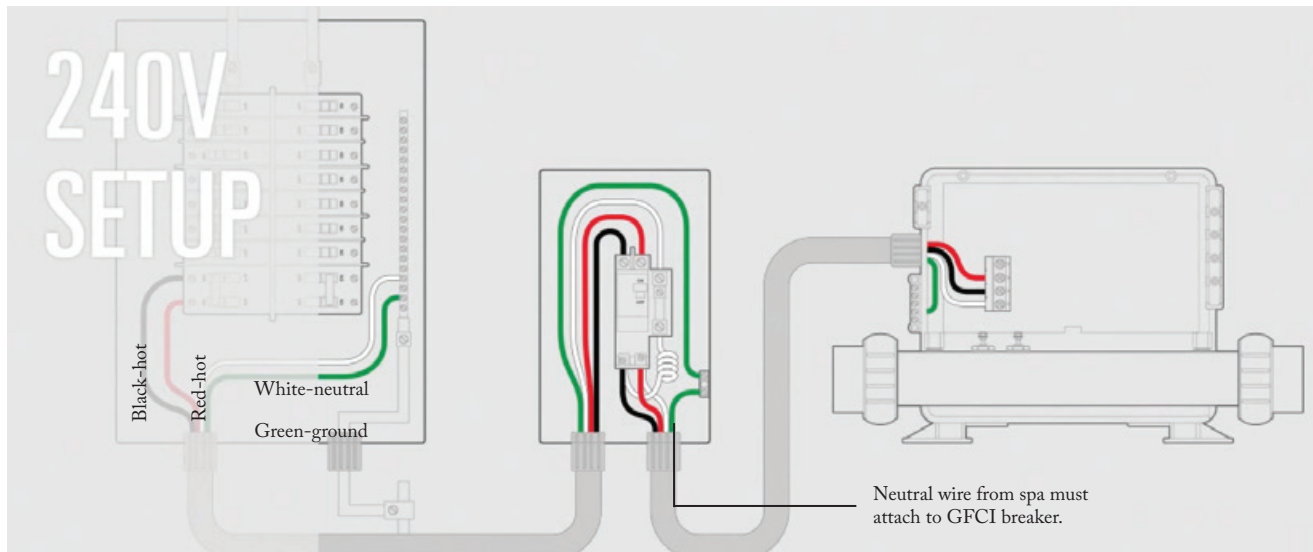

60Hz install (typical US/Canada)

# Hardware Setup/Wiring Diagram BFBP20S (60 Hz STIL Model)

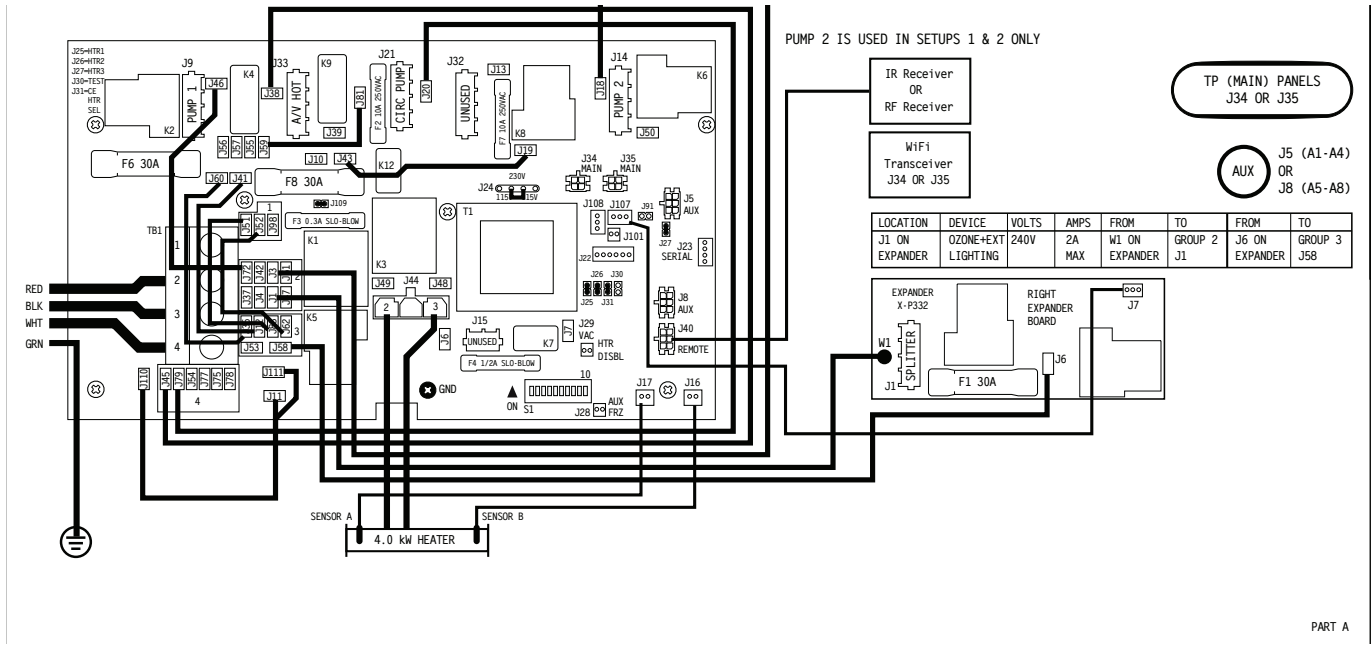

PART A

## Settings

LOCATION	DEVICE	VOLTS	MAX AMPS	FROM	TO
J9	2-SP PUMP 1	240V	12A MAX	J46	J72-GROUP 2
J14	2-SP PUMP 2	240V	12A MAX	J18	J3-GROUP 2
	PUMP 2 LINE 1 CONNECTION			J19	J43
J21	CIRC PUMP	120V	2A MAX	J20	J79-GROUP 4
J32	UNUSED				
	CIRC PUMP LINE 1 CONNECTION			J81	J59
J33	TV / AV	120V	3A	J38	J45-GROUP 4
J44	HEATER	240V	4.0 KW		
J6 & J7	TRANSULATOR	12V	0.1A		

PUMP 2 IS USED IN SETUPS 1 & 2 ONLY

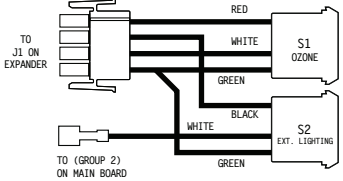

SETUP #	CIRC PUMP	PUMP 1	PUMP 2	TEMP SCALE
1	PROGRAMMABLE FILTRATION + POLLING	2-SPEED	2-SPEED	°F
2	NONE	2-SPEED	2-SPEED	°F
3	PROGRAMMABLE FILTRATION + POLLING	2-SPEED		°F
4	NONE	2-SPEED		°F

SYSTEM WILL BE IN SETUP #2 UNLESS MARKED DIFFERENTLY BELOW

PUMP 1 LOW TIMEOUT IS 60 MINUTES.

INSTEAD OF SETUP #2, THIS SYSTEM IS CONFIGURED IN SETUP #:

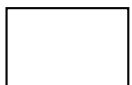

SWITCHBANK S1 OFF

SWITCHBANK S1 ON

TEST MODE OFF	◀ A1	TEST MODE ON
DON'T ADD 1 HS PUMP W/HTR	◀ A2	ADD 1 HS PUMP WITH HEAT
DON'T ADD 2 HS PUMPS W/HTR	▶ A3	ADD 2 HS PUMPS WITH HEAT
DON'T ADD 4 HS PUMPS W/HTR	▶ A4	ADD 4 HS PUMPS WITH HEAT
SPECIAL AMPERAGE RULE A	▶ A5	SPECIAL AMPERAGE RULE A
STORE SETTINGS*	▶ A6	MEMORY RESET*
NOT ASSIGNED	▶ A7	NOT ASSIGNED
NOT ASSIGNED	▶ A8	NOT ASSIGNED
NOT ASSIGNED	▶ A9	NOT ASSIGNED
NOT ASSIGNED	▶ A10	NOT ASSIGNED

\*SWITCH # 6 SHOULD BE SET TO OFF UPON FINAL INSTALLATION.

USE COPPER CONDUCTORS ONLY.  
EMPLOYER UNIQUEMENT DES CONDUCTEURS DE CUIVRE.  
#6 AWG MIN. WIRE = 90"

FOR SUPPLY CONNECTIONS, USE CONDUCTORS SIZED ON THE BASIS OF 60°C AMPACITY BUT RATED MINIMUM OF 90°C.

TORQUE RANGE FOR MAIN TERMINAL BLOCK (TB1):  
27-30 IN. LBS. (31.1-34.5 kg cm)

CONNECT ONLY TO CIRCUITS PROTECTED BY A CLASS A GFCI.

A DISCONNECTING MEANS MUST BE INSTALLED WITHIN SIGHT FROM THE EQUIPMENT AND AT LEAST 5 FEET (1.52 M) FROM THE INSIDE WALLS OF THE POOL, SPA, OR HOT TUB.

TOTAL OUTPUT AMP DRAW NOT TO EXCEED MAX INPUT RATING OF SPA  
USE EARTH GROUND CONNECTIONS AS INDICATED INSIDE THE SYSTEM ENCLOSURE

# Hardware Setup/Wiring Diagram BFBP21S (50 Hz STIL Model)

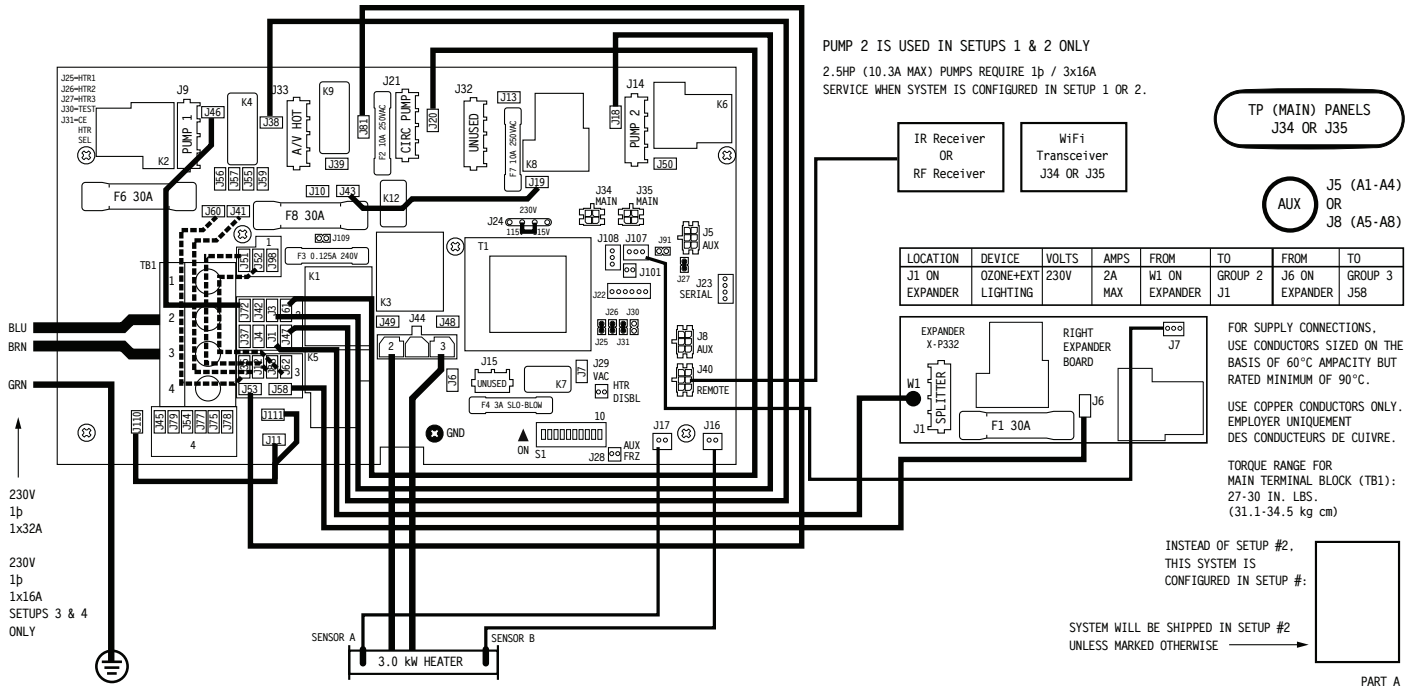

## Settings

SINGLE SERVICE 230V 1p / 1x32A, TWO-SERVICE 230V 1p / 2x16A, THREE-SERVICE 230V 1p / 3x16A

LOCATION	DEVICE
J9	NETZSTROMVERSORGUNG 2-GESCHW.-PUMPE 1 ALIMENTATION POMPE 1 A 2 VITESSES 2-SPEED PUMP 1
J14	NETZSTROMVERSORGUNG 2-GESCHW.-PUMPE 2 ALIMENTATION POMPE 2 A 2 VITESSES 2-SPEED PUMP 2
	PUMP 2 LINE 1 CONNECTION J19 to J43
J21	KREISLAUF PUMPE POMPE DE CIRCULATION CIRC PUMP
	CIRC AND OZONE LINE 1 CONNECTION J81 to J59
J32	N/A
J33	TV / AV
J40	IR RECIEVER
J5, J8	AUX PANEL(S) - AX10, AX20, AX30, AX40

SETUP #	CIRC PUMP	PUMP 1	PUMP 2	TEMP SCALE
1*	PROGRAMMABLE FILTRATION + POLLING	2-SPEED	2-SPEED	°C
2*	PROGRAMMABLE FILTRATION + POLLING	2-SPEED	2-SPEED	°C
3	PROGRAMMABLE FILTRATION + POLLING	2-SPEED	2-SPEED	°C
4	PROGRAMMABLE FILTRATION + POLLING	2-SPEED	2-SPEED	°C

PUMP 1 LOW TIMEOUT IS 60 MINUTES.

LOCATION	DEVICE	VOLTS	MAX AMPS	USING SPLITTER
J1 ON EXPANDER	OZONE + EXT. LIGHTING	230V	1A	USING SPLITTER

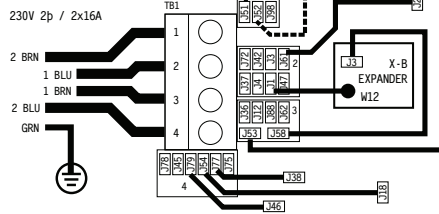
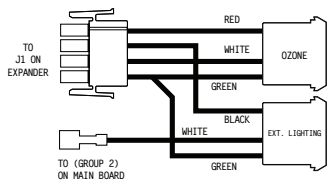

SWITCHBANK S1 OFF	SWITCHBANK S1 ON
TEST MODE OFF	TEST MODE ON
DON'T ADD 1 HS PUMP W/HTR	ADD 1 HS PUMP WITH HEAT
DON'T ADD 2 HS PUMPS W/HTR	ADD 2 HS PUMPS WITH HEAT
DON'T ADD 4 HS PUMPS W/HTR	ADD 4 HS PUMPS WITH HEAT
SPECIAL AMPERAGE RULE A	SPECIAL AMPERAGE RULE B
STORE SETTINGS**	MEMORY RESET**
NOT ASSIGNED	NOT ASSIGNED
NOT ASSIGNED	NOT ASSIGNED
NOT ASSIGNED	NOT ASSIGNED
NOT ASSIGNED	NOT ASSIGNED
NOT ASSIGNED	NOT ASSIGNED

\*\*SWITCH # 6 SHOULD BE SET TO OFF UPON FINAL INSTALLATION.

230V 1p 1X16A

OFF ON

▲ A2

▲ A3

▲ A4

\* 2.5HP (10.3A MAX) PUMPS REQUIRE 1p / 3x16A SERVICE WHEN SYSTEM IS CONFIGURED IN SETUP 1 OR 2.

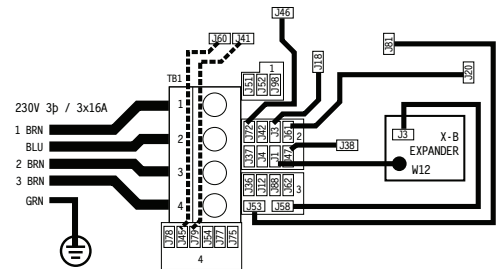



# Hardware Setup/Wiring Diagram BFBP20 (60 Hz A&R Series Models)

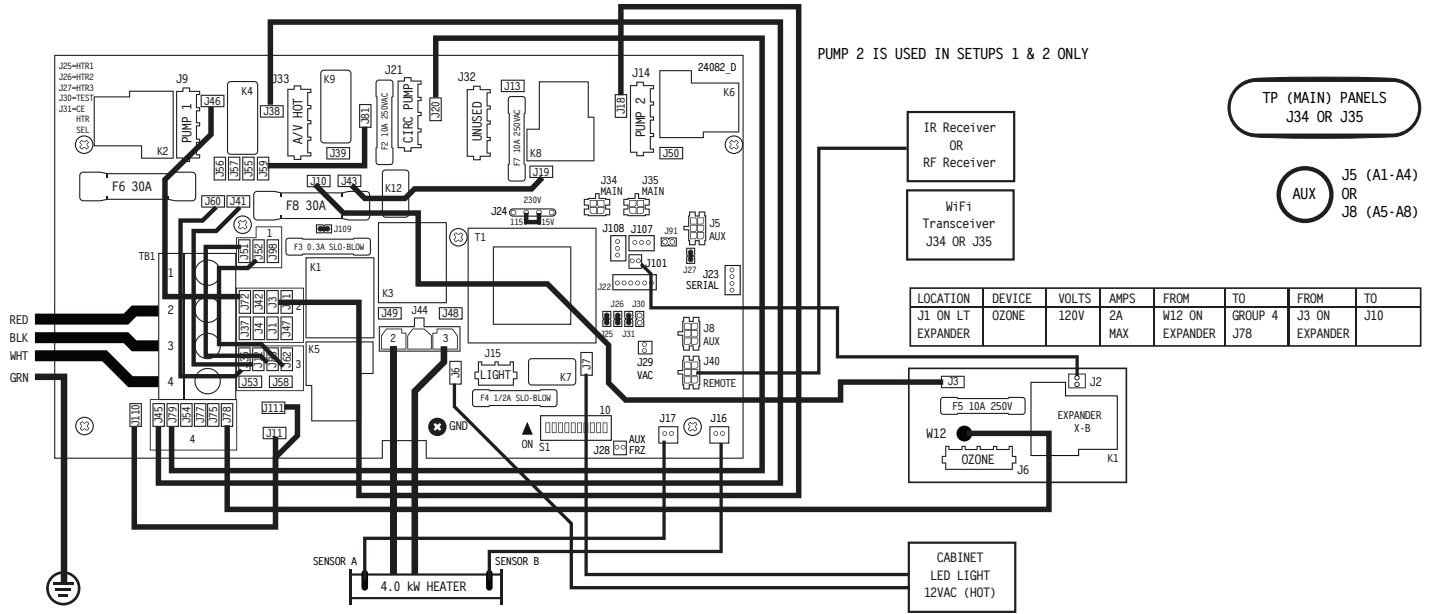

## Settings

LOCATION	DEVICE	VOLTS	MAX AMPS	FROM	TO
J9	2-SP PUMP 1	240V	12A MAX	J46	J72-GROUP 2
J14	2-SP PUMP 2	240V	12A MAX	J18	J3-GROUP 2
	PUMP 2 LINE 1 CONNECTION			J19	J43
J15	SPA LIGHT	12V	1A		
J21	CIRC PUMP	120V	2A MAX	J20	J79-GROUP 4
J32	UNUSED				
	CIRC PUMP LINE 1 CONNECTION			J81	J59
J33	TV / AV	120V	3A	J38	J45-GROUP 4
J44	HEATER	240V	4.0 kW		
J6 & J7	CABINET LED	12V	0.1A		

PUMP 2 IS USED IN SETUPS 1 & 2 ONLY

LOCATION	DEVICE	VOLTS	MAX AMPS
J6 ON EXPANDER BOARD X-B	OZONE	120V	2A MAX

SETUP #	CIRC PUMP	PUMP 1	PUMP 2	TEMP SCALE
1	PROGRAMMABLE FILTRATION + POLLING	2-SPEED	2-SPEED	°F
2		2-SPEED	2-SPEED	°F
3	PROGRAMMABLE FILTRATION + POLLING	2-SPEED		°F
4		2-SPEED		°F

SYSTEM WILL BE IN SETUP #2 UNLESS MARKED DIFFERENTLY BELOW

PUMP 1 LOW TIMEOUT IS 60 MINUTES.

INSTEAD OF SETUP #2, THIS SYSTEM IS CONFIGURED IN SETUP #:



### SWITCHBANK S1 OFF

TEST MODE OFF	SWITCHBANK S1 ON
TEST MODE OFF	TEST MODE ON
DON'T ADD 1 HS PUMP W/HTR	A1
DON'T ADD 2 HS PUMPS W/HTR	A2
DON'T ADD 4 HS PUMPS W/HTR	A3
SPECIAL AMPERAGE RULE A	A4
STORE SETTINGS*	A5
NOT ASSIGNED	A6
NOT ASSIGNED	A7
NOT ASSIGNED	A8
NOT ASSIGNED	A9
NOT ASSIGNED	A10

\*SWITCH # 6 SHOULD BE SET TO OFF UPON FINAL INSTALLATION.

USE COPPER CONDUCTORS ONLY.  
EMPLOYER UNIQUEMENT DES CONDUCTEURS DE CUIVRE.  
#6 AWG MIN. WIRE = 90°

FOR SUPPLY CONNECTIONS, USE CONDUCTORS SIZED ON THE BASIS OF 60°C AMPACITY BUT RATED MINIMUM OF 90°C.

TORQUE RANGE FOR MAIN TERMINAL BLOCK (TB1):  
27-30 IN. LBS. (31.1-34.5 kg cm)

CONNECT ONLY TO CIRCUITS PROTECTED BY A CLASS A GFCI.

A DISCONNECTING MEANS MUST BE INSTALLED WITHIN SIGHT FROM THE EQUIPMENT AND AT LEAST 5 FEET (1.52 M) FROM THE INSIDE WALLS OF THE POOL, SPA, OR HOT TUB.

TOTAL OUTPUT AMP DRAW NOT TO EXCEED MAX INPUT RATING OF SPA USE EARTH GROUND CONNECTIONS AS INDICATED INSIDE THE SYSTEM ENCLOSURE



BFBP20 - PN 56340-01

01-24-13

PART B

# Hardware Setup/Wiring Diagram BFS501 (60 Hz X Series Models)

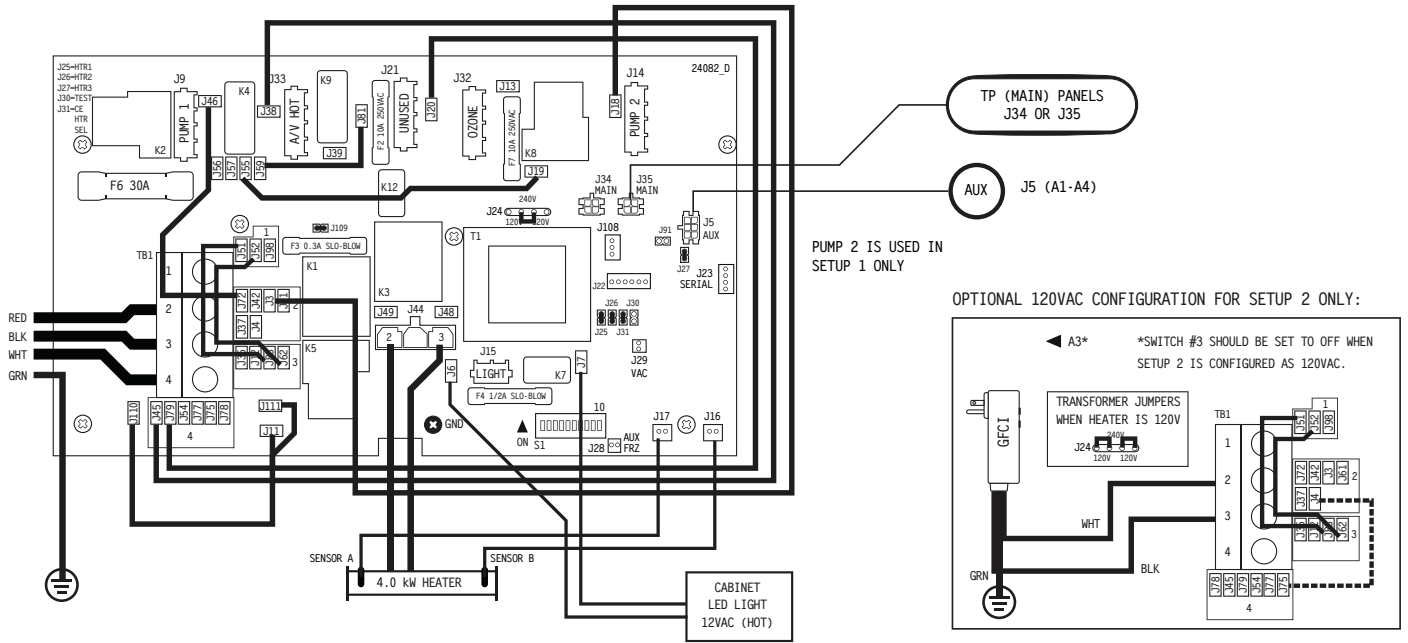

PART A

## Settings

LOCATION	DEVICE	VOLTS	MAX AMPS	FROM	TO
J9	2-SP PUMP 1	240V	12A MAX	J46	J72-GROUP 2
J9	2-SP PUMP 1	120V	12A MAX	J46	J72-GROUP 2
J14	1-SP PUMP 2	240V	12A MAX	J18	J33-GROUP 2
J14	PUMP 2 LINE 1 CONNECTION			J19	J55
J15	SPA LIGHT	10V	1A		
J21	UNUSED	120V	2A MAX	J20	J79-GROUP 4
J32	OZONE				
J33	TV / AV	120V	3A	J38	J45-GROUP 4
J44	HEATER	240V	4.0 kW		
J44	HEATER	120V	1.0 kW		
J6 & J7	CABINET LED	12V	0.1A		

PUMP 1 CAN BE 120V IN SETUP 2 ONLY.  
PUMP 2 IS USED IN SETUP 1 ONLY

HEATER CAN BE 120V IN SETUP 2 ONLY.

SETUP #	CIRC PUMP	PUMP 1	PUMP 2	TEMP SCALE
1		2-SPEED	1-SPEED	°F
2		2-SPEED		°F

FOR 120V SYSTEMS, USE SETUP 2 ONLY.

PUMP 1 LOW TIMEOUT IS 60 MINUTES.

INSTEAD OF SETUP #2, THIS SYSTEM IS CONFIGURED IN SETUP #:



SYSTEM WILL BE IN SETUP #2 UNLESS MARKED DIFFERENTLY BELOW

### SWITCHBANK S1 OFF

### SWITCHBANK S1 ON

TEST MODE OFF	◀ A1	TEST MODE ON
DON'T ADD 1 HS PUMP W/HTR	◀ A2	ADD 1 HS PUMP WITH HEAT
DON'T ADD 2 HS PUMPS W/HTR	A3* ▶	ADD 2 HS PUMPS WITH HEAT
DON'T ADD 4 HS PUMPS W/HTR	◀ A4	ADD 4 HS PUMPS WITH HEAT
SPECIAL AMPERAGE RULE A	◀ A5	SPECIAL AMPERAGE RULE B
STORE SETTINGS**	◀ A6	MEMORY RESET*
NOT ASSIGNED	◀ A7	NOT ASSIGNED
NOT ASSIGNED	◀ A8	NOT ASSIGNED
NOT ASSIGNED	◀ A9	NOT ASSIGNED
NOT ASSIGNED	◀ A10	NOT ASSIGNED

\*SWITCH #3 SHOULD BE SET TO OFF WHEN SETUP 2 IS CONFIGURED AS 120VAC.

\*\*SWITCH # 6 SHOULD BE SET TO OFF UPON FINAL INSTALLATION.

USE COPPER CONDUCTORS ONLY.  
EMPLOYER UNIQUEMENT DES CONDUCTEURS DE CUIVRE.  
#6 AWG MIN. WIRE = 90°

FOR SUPPLY CONNECTIONS, USE CONDUCTORS SIZED ON THE BASIS OF 60°C AMPACITY BUT RATED MINIMUM OF 90°C.

TORQUE RANGE FOR MAIN TERMINAL BLOCK (TB1):  
27-30 IN. LBS. (31.1-34.5 kg cm)

CONNECT ONLY TO CIRCUITS PROTECTED BY A CLASS A GFCI.

A DISCONNECTING MEANS MUST BE INSTALLED WITHIN SIGHT FROM THE EQUIPMENT AND AT LEAST 5 FEET (1.52 M) FROM THE INSIDE WALLS OF THE POOL, SPA, OR HOT TUB.

TOTAL OUTPUT AMP DRAW NOT TO EXCEED MAX INPUT RATING OF SPA  
USE EARTH GROUND CONNECTIONS AS INDICATED INSIDE THE SYSTEM ENCLOSURE

**BALBOA**  
water group

**BFBP20GX - PN 56454**  
01-24-13

PART B

# Hardware Setup/Wiring Diagram BFBP21 (50 Hz A Series, R Series, and X Series models.)

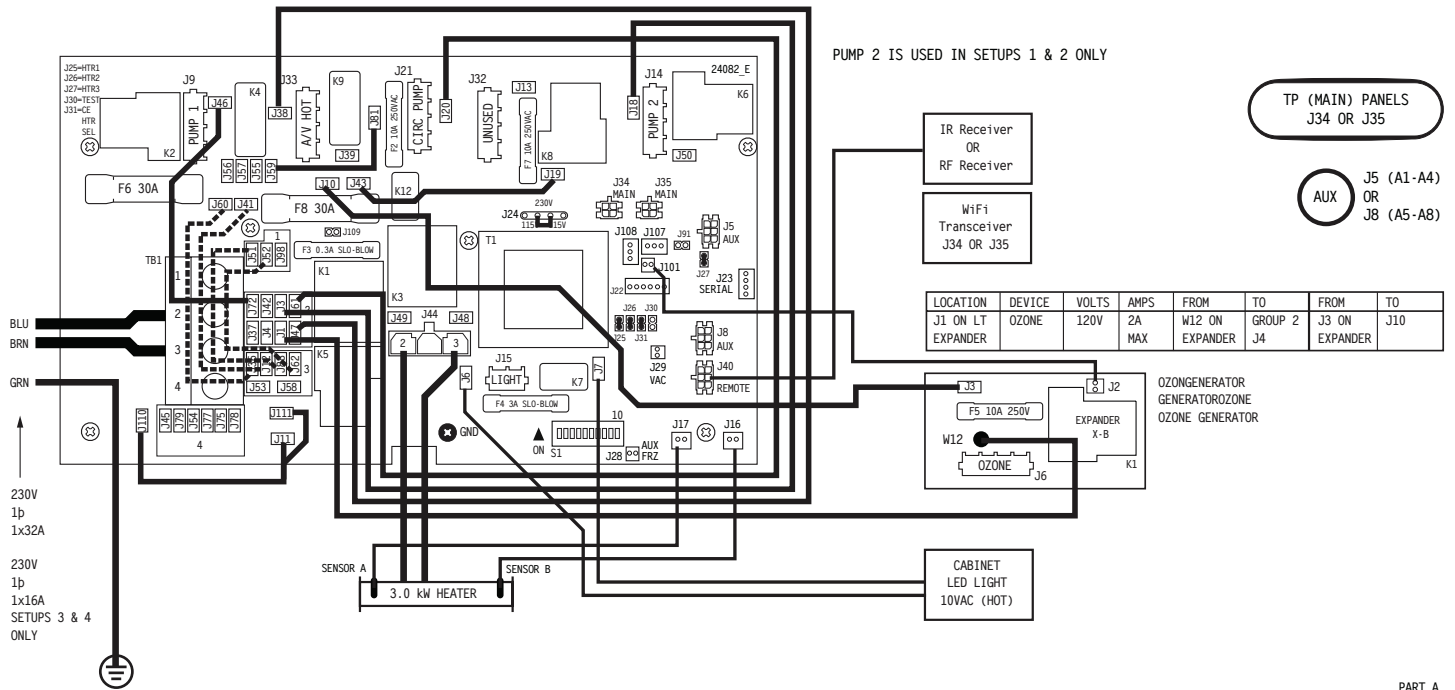

PART A

## Settings

SINGLE SERVICE 230V 1p / 1x32A, TWO-SERVICE 230V 1p / 2x16A, THREE-SERVICE 230V 1p / 3x16A

LOCATION	DEVICE
J9	NETZSTROMVERSORGUNG 2-GESCHW.-PUMPE 1 ALIMENTATION POMPE 1 A 2 VITESSES 2-SPEED PUMP 1
J14	NETZSTROMVERSORGUNG 2-GESCHW.-PUMPE 2 ALIMENTATION POMPE 2 A 2 VITESSES 2-SPEED PUMP 2
	PUMP 2 LINE 1 CONNECTION J19 to J43
J15	10V BELEUCHTUNG ECLAIRAGE BAIN HYDRO SPA LIGHT
J21	KREISLAUF PUMPE POMPE DE CIRCULATION CIRC PUMP
	CIRC AND OZONE LINE 1 CONNECTION J81 to J59
J32	N/A
J33	TV / AV
J40	IR RECIEVER
J5, J8	AUX PANEL(S) - AX10, AX20, AX30, AX40

CIRC PUMP OPTION PROGRAMMABLE FILTRATION CYCLES + POLLING USED IN SETUPS 1 & 3

SWITCHBANK S1 OFF		SWITCHBANK S1 ON	
TEST MODE OFF	◀ A1	TEST MODE ON	▶ A1
DON'T ADD 1 HS PUMP W/HTR	◀ A2	ADD 1 HS PUMP WITH HEAT	▶ A2
DON'T ADD 2 HS PUMPS W/HTR	◀ A3	ADD 2 HS PUMPS WITH HEAT	▶ A3
DON'T ADD 4 HS PUMPS W/HTR	◀ A4	ADD 4 HS PUMPS WITH HEAT	▶ A4
SPECIAL AMPERAGE RULE A*	◀ A5	SPECIAL AMPERAGE RULE B*	▶ A5
STORE SETTINGS**	◀ A6	MEMORY RESET**	▶ A6
NOT ASSIGNED	◀ A7	NOT ASSIGNED	▶ A7
NOT ASSIGNED	◀ A8	NOT ASSIGNED	▶ A8
NOT ASSIGNED	◀ A9	NOT ASSIGNED	▶ A9
NOT ASSIGNED	◀ A10	NOT ASSIGNED	▶ A10

SETUP #	CIRC PUMP	PUMP 1	PUMP 2	TEMP SCALE
1	PROGRAMMABLE FILTRATION + POLLING	2-SPEED	2-SPEED	°C
2		2-SPEED	2-SPEED	°C
3	PROGRAMMABLE FILTRATION + POLLING	2-SPEED	2-SPEED	°C
4		2-SPEED		°C

SYSTEM WILL BE IN SETUP #1 UNLESS MARKED DIFFERENTLY BELOW

PUMP 1 LOW TIMEOUT IS 60 MINUTES.

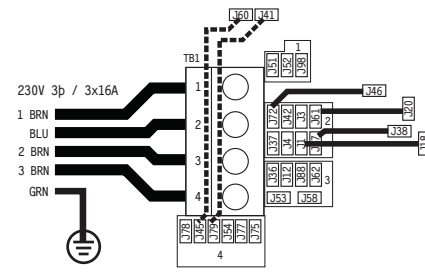
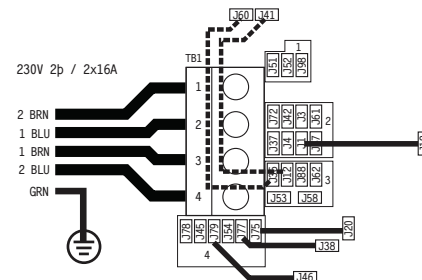

FOR SUPPLY CONNECTIONS, USE CONDUCTORS SIZED ON THE BASIS OF 60°C AMPACITY BUT RATED MINIMUM OF 90°C.

USE COPPER CONDUCTORS ONLY. EMPLOYER UNIQUEMENT DES CONDUCTEURS DE CUIVRE.

TORQUE RANGE FOR MAIN TERMINAL BLOCK (TB1): 27-30 IN. LBS. (31.1-34.5 kg cm)



BFBP21 - PN 56342  
11-28-12

47  
PART B

INSTEAD OF SETUP #1, THIS SYSTEM IS CONFIGURED IN SETUP #:  
SYSTEM WILL BE SHIPPED IN SETUP #1 UNLESS MARKED OTHERWISE

\*\*SWITCH # 6 SHOULD BE SET TO OFF UPON FINAL INSTALLATION.

# DISPLAY MESSAGES & ERROR MESSAGES

## General Messages

Most messages and alerts will appear on the main screen. Several alerts and messages may be displayed in a sequence. Some messages can be reset by pushing the “jets” button.

-- °F -- °C

### **Water Temperature is Unknown**

After the pump has been running for 1 minute, the temperature will be displayed.

### **Possible freezing condition**

A potential freeze condition has been detected. All water devices are activated. In some cases, pumps may turn on and off and the heater may operate during

### **Freeze Protection.**

This is an operational message, not an error indication.

### **The water is too hot**

The system has detected a spa water temp of 110°F (43.3°C) or more, and spa functions are disabled. System will auto reset when the spa water temp is below 108°F (42.2°C). Check for extended pump operation or high ambient temp.

## Heater-Related Messages

### **The water flow is low**

There may not be enough water flow through the heater to carry the heat away from the heating element. Heater start up will begin again after about 1 min.

See “Flow Related Checks” below.

### **The water flow has failed\***

There is not enough water flow through the heater to carry the heat away from the heating element and the heater has been disabled.

See “Flow Related

Checks” below. After the problem has been resolved, you must press any button to reset and begin heater start up.

### **The heater may be dry\***

Possible dry heater, or not enough water in the heater to start it. The spa is shut down for 15 min. Press any button to reset the heater start-up. See “Flow

Related Checks” below.

### **The heater is dry\***

There is not enough water in the heater to start it. The spa is shut down. After the problem has been resolved, you must clear the message to restart heater start

up. See “Flow Related Checks” below.

### **The heater is too hot\***

One of the water temp sensors has detected 118°F (47.8°C) in the heater and the spa is shut down. You must clear the message when water is below 108°F

(42.2°C). See “Flow Related Checks” below.

## Flow-Related Checks

Check for low water level, suction flow restrictions, dirty filters, trapped air, too many closed jets and pump prime. On some systems, even when spa is shut

down by an error condition, some equipment may occasionally turn on to continue monitoring temperature or if freeze protection is needed.

- This message can be reset from the control panel.



## Sensor-Related Messages

---

### **Sensors are out of sync**

The temperature sensors MAY be out of sync by 2°F or 3°F. Call for Service.

---

### **Sensors are out of sync -Call for service\***

The temperature sensors ARE out of sync. The fault above has been established for at least 1 hour. Call for Service.

---

### **Sensor A Fault, Sensor B Fault – Sensor A, Sensor B**

A temperature sensor or sensor circuit has failed. Call for Service.

---

## Miscellaneous Messages

---

### **Communications error**

The control panel is not receiving communication from the System. Call for Service.

---

### **Test software installed**

The Control System is operating with test software. Call for Service.

---

### **°F or °C is replaced by °T**

The Control System is in Test Mode. Call for Service.

\*This message can be reset from the control panel.

---

## System-Related Messages

---

### **Program memory failure\***

At Power-Up, the system has failed the Program Checksum Test. This indicates a problem with the firmware (operation program) and requires a service call.

---

### **The settings have been reset (Persistent Memory Error)\***

Contact your dealer or service organization if this message appears on more than one powerup.

---

### **The clock has failed\***

Contact your dealer or service organization.

Configuration error (Spa will not Start Up)

Contact your dealer or service organization.

---

### **The GFCI test failed (System Could Not Test the GFCI)**

(North America Only) May indicate an unsafe installation. Contact your dealer or service organization.

---

### **A pump may be stuck on**

Water may be overheated. POWER DOWN THE SPA. DO NOT ENTER THE WATER. Contact your dealer or service organization.

---

### **Hot fault**

A Pump Appears to have been Stuck ON when spa was last powered. POWER DOWN THE SPA. DO NOT ENTER THE WATER. Contact your dealer or service organization.

\*This message can be reset from the control panel.

---

## Reminder Messages

---

### General maintenance helps.

Reminder Messages are suppressed from the factory, but can be activated in the settings by using the Preferences Menu. See Page 14.

---

### Clean the filter

May appear on a regular schedule, i.e. every 30 days. Clean the filter media as instructed in the owner's manual. See Filter Maintenance.

---

### Test the GFCI

Will appear every 65 days.

The GFCI is an important safety device and must be tested on a regular basis to verify its reliability.

A GFCI will have a TEST and RESET button on it that allows a user to verify proper function.

---

### Change the water

Will appear every 100 days.

Change the water in the spa on regular basis to maintain proper chemical balance and sanitary conditions.

---

### Change the filter

Will every 365 days.

Filters should be replaced occasionally to maintain proper spa function and sanitary conditions.

Reminder messages can be reset from the control panel.

## R600 General Messages

---



### Priming Mode

Each time the spa is powered up, it will enter Priming Mode. The purpose of Priming Mode is to allow the user to run each pump and manually verify that the pumps are primed (air is purged) and water is flowing. This typically requires observing the output of each pump separately, and is generally not possible in normal operation. Priming Mode lasts 4 minutes, but you can exit it earlier by pressing any Temp button. The heater is not allowed to run during Priming Mode.

**NOTE:** If your spa has a Circ Pump, it will turn on with Jets 1 in Priming Mode. The Circ Pump will run by itself when Priming Mode is exited.

---



### Water Temperature is Unknown

After the pump has been running for 1 minute, the temperature will be displayed.

---



### Too Cold Freeze Protection

A potential freeze condition has been detected, and all pumps and blower are activated. All pumps and blower are ON for at least 4 minutes after the potential freeze condition has ended. In some cases, pumps may turn on and off and the heater may operate during Freeze Protection. This is an operational message, not an error indication.



### Water is too Hot (OHS)

One of the water temp sensors has detected spa water temp 110°F (43.3°C) and spa functions are disabled. System will auto reset when the spa water temp is below 108°F (42.2°C). Check for extended pump operation or high ambient temp.

## Heater-Related Messages



### Heater Flow is Reduced (HFL)

There may not be enough water flow through the heater to carry the heat away from the heating element. Heater start up will begin again after about 1 min. See “Flow Related Checks” below.



### Heater Flow is Reduced (LF)\*

There is not enough water flow through the heater to carry the heat away from the heating element and the heater has been disabled. See “Flow Related Checks” below. After the problem has been resolved, you must press any button to reset and begin heater start up.



### Heater may be Dry (dr)\*

Possible dry heater, or not enough water in the heater to start it. The spa is shut down for 15 min. Press any button to reset the heater start-up. See “Flow Related Checks” below.



### Heater is Dry\*

There is not enough water in the heater to start it. The spa is shut down. After the problem has been resolved, you must press any button to reset and restart heater start up. See “Flow Related Checks” below.



### Heater is too Hot (OHH)\*

One of the water temp sensors has detected 118°F (47.8°C) in the heater and the spa is shut down. You must press any button to reset when water is below 108°F (42.2°C). See “Flow Related Checks” below.



### A Reset Message may Appear with other Messages.

Some errors may require power to be removed and restored.

## Flow-Related Checks

Check for low water level, suction flow restrictions, closed valves, trapped air, too many closed jets and pump prime.

On some systems even when spa is shut down, some equipment may occasionally turn on to continue monitoring temperature or

if freeze protection is needed.

*\*This message can be reset from the control panel with any button press.*

## Sensor-Related Messages

---



### Sensor Balance is Poor

The temperature sensors MAY be out of sync by 2°F or 3°F. Call for Service.



### Sensor Balance is Poor\*

The temperature sensors ARE out of sync. The Sensor Balance is Poor fault has been established for at least 1 hour. Call for Service.



### Sensor Failure – Sensor A, Sensor B

A temperature sensor or sensor circuit has failed. Call for Service.

## Miscellaneous Messages

---



### No Communications

The control panel is not receiving communication from the System. Call for Service.



### Pre-Production Software

The Control System is operating with test software. Call for Service.



### °F or °C is replaced by °T

The Control System is in Test Mode. Call for Service.

*\*This message can be reset from the control panel.*

## System-Related Messages

---



### Memory Failure Checksum Error\*

At Power-Up, the system has failed the Program Checksum Test. This indicates a problem with the firmware (operation program) and requires a service call.

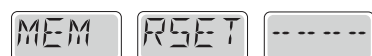

### Memory Warning Persistent Memory Reset\*

Appears after any system setup change. Contact your dealer or service organization if this message appears on more than one power-up, or if it appears after the system has been running normally for a period of time.





### Memory Failure Clock Error\*

Contact your dealer or service organization.

---



### GFCI Failure System Could Not Test/Trip the GFCI NORTH AMERICA ONLY.

May indicate an unsafe installation. Contact your dealer or service organization.

---



### A Pump Appears to be Stuck ON

Water may be overheated. POWER DOWN THE SPA. DO NOT ENTER THE WATER. Contact your dealer or service organization.

---



### Configuration Error – Spa will not Start Up

Contact your dealer or service organization.

---



### Memory Warning Persistent Memory Reset\*

Appears after any system setup change. Contact your dealer or service organization if this message appears on more than one power-up, or if it appears after the system has been running normally for a period of time.

---

*\*This message can be reset from the control panel.*

## Reminder Messages

---

### General maintenance helps

Reminder Messages are suppressed in the default programming, but can be activated by using the PREF Menu. Press a Temperature button to reset a displayed reminder message.

---



Alternates with temperature or normal display.

### Appears on a regular schedule, e.g. every 30 days.

Clean the filter media as instructed by the owner's manual. See Filter Maintenance.

---



Alternates with temperature or normal display.

### Appears every 65 days.

The Ground Fault Circuit Interrupter (GFCI) is an important safety device and must be tested on a regular basis to verify its reliability. Every user should be trained to safely test the GFCI associated with the hot tub installation. A GFCI will have a TEST and RESET button on it that allows a user to verify proper function.

**WARNING:** If freezing conditions exist, a GFCI should be reset immediately or spa damage could result.



Alternates with temperature or normal display.

**Appears on a regular schedule, e.g. every 90 days.**

Change the water in the spa on regular basis to maintain proper chemical balance and sanitary conditions.

---



Alternates with temperature or normal display.

**Appears every 365 days.**

Filters should be replaced occasionally to maintain proper spa function and sanitary conditions.

# **TROUBLESHOOTING GUIDE**

This guide will assist in solving simple problems with the spa. If the problem cannot be solved using these procedures, contact your authorized Bullfrog Spas Dealer.

## **Control panel displays an error message:**

**Cause:** An error has occurred.

**Solution:** See Diagnostic Messages for specific errors.

## **Control pad and spa equipment do not operate:**

**Cause #1:** No electrical power to spa.

**Solution:** Turn on or reset the GFCI circuit breaker. If this does not solve the problem, have a qualified Electrician check the electrical service.

**Cause #2:** The 20 or 30A fuse, depending on the system, has blown.

**Solution:** Contact your authorized Bullfrog Spas Dealer.

## **GFCI breaker trips repeatedly:**

**Cause #1:** Improper wiring to spa or GFCI breaker is defective.

**Solution:** Consult with a qualified Electrician.

**Cause #2:** There is a defective component on the spa.

**Solution:** Contact your authorized Bullfrog Spas Dealer.

## **Spa pump turns off during operation:**

**Cause #1:** Automatic timer has completed its 30 or 60 minute cycle.

**Solution:** Turn on the pump.

**Cause #2:** Pump has overheated due to the vents on the equipment door being blocked.

**Solution:** Clear items away from vents.

**Cause #3:** The pump motor is defective.

**Solution:** Contact your authorized Bullfrog Spas Dealer.

## **Spa will not heat:**

**Cause #1:** Thermostat has been turned down or set to low heat range.

**Solution:** Adjust thermostat to desired temperature or set to high heat range.

**Cause #2:** High limit sensor has tripped.

**Solution:** Press any button to reset.

**Cause #3:** Heating system is defective.

**Solution:** Contact your authorized Bullfrog Spas Dealer.

## **Standard Spa light does not work:**

**Cause #1:** Light bulb has burned out.

**Solution:** Replace light bulb.

**Cause #2:** Lighting system is defective.

**Solution:** Contact your authorized Bullfrog Spas Dealer.

## **Jets surge on and off:**

**Cause:** Water level is too low or filters may be dirty.

**Solution:** Adjust water to the water level indication mark on the faceplate of the filter assembly. Clean the filters.

## **Spa pump will not turn on, creates a burning smell while running, or makes excessive noise while running:**

**Cause:** Pump motor is defective. Running during high ambient outside temperatures, Excessive run time

**Solution:** Contact your authorized Bullfrog Spas Dealer.

## **Jets are weaker than normal or do not work at all, but the pump is running:**

**Cause #1:** Jet handle(s) X Series are partially or fully closed. Valves are closed Series A & R JetPak II,

**Solution:** Open jet handle(s) / valve(s).

**Cause #2:** Filter cartridge is dirty.

**Solution:** See Cleaning the Filter.

**Cause #3:** There is air trapped in the spa equipment or its face piping.

**Solution:** Remove the clamp to the air bleed line and remove the air line from the pump until air has purged out and you see water flow and reconnect.

**Cause #4:** The suction fitting(s) are blocked.

**Solution:** Remove any debris that may be blocking the suction fitting(s).

# **LIMITED WARRANTY**

Bullfrog International, LC (“Bullfrog”) extends warranty coverage solely to the end-user purchaser (“Owner”) of any portable Bullfrog Spa manufactured on or after February 18, 2013 for 2013 and later models installed for residential use in the United States or Canada.

	<b>A &amp; S Series</b>	<b>R Series</b>	<b>X Series</b>
<b>EnduraFrame</b>	Lifetime	Lifetime	5 Years
<b>Shell Structure</b>	10 Years	7 Years	5 Years
<b>Shell Surface</b>	7 Years	5 Years	3 Years
<b>Components/ JetPaks/ Cabinet</b>	5 Years	5 Years	3 Years
<b>Lighting/ Stereo System/ Ozone System</b>	1 Year	1 Year	1 Year

## **WARRANTY**

Bullfrog International, LC (“Bullfrog”) extends warranty coverage solely to the end-user purchaser (“Owner”) of any portable Bullfrog Spa manufactured on or after February 18, 2013 for 2013 and later models installed for residential use in the United States or Canada.

### **Lifetime Warranty**

#### **EnduraFrame™**

Bullfrog warrants the EnduraFrame (injectionmolded spa frame) against degradation for the life of the original retail purchaser of the spa.

### **10 Year Warranty**

#### **Shell Structure**

Bullfrog warrants the Bullfrog Spa shell not to leak for ten years from the original spa purchase date.

### **7 Year Warranty**

#### **Shell Surface**

Bullfrog warrants the surface finish of the Bullfrog Spa not to crack, wrinkle, blister, peel or delaminate for seven years from the original spa purchase date.

### **5 Year Warranty**

#### **Equipment**

- Warranty specifically covers the pump(s), heater, control system (including fuses), Snap Caps™, FilterCap™, other Bullfrog mechanical equipment, and leaks from any component or plumbing fitting located beneath the spa shell.
- Electrical and mechanical equipment with its associated piping and fittings warranted against defects in materials and workmanship for five years from purchase date.
- Defective components that are easily removed from the spa and that can be readily re placed by the customer and do not require specialized tools or knowledge or create personal safety issues, all of which are deemed Easily Removed Components, will be repaired or replaced free of charge at your authorized Bullfrog Spa Dealer or by sending the defective component(s) to Bullfrog. This warranty excludes audio systems, the ozone system, and the interior and exterior spa lighting systems.

#### **EternaWood Cabinet**

- Warranty specifically covers the cabinet corners, door and side panels, and the molded spa base.
- EternaWood Cabinet sections (corners, doors, side panels) & EnduraBase™ are warranted against degradation and cracking for five years from purchase date. Deffective items will be replaced under the terms of this warranty.

#### **JetPak Therapy System**



- Warranty specifically covers the jets, any leaks from JetPak jet fittings, and all JetPak plumbing.
- JetPak plumbing System warranted for five years from purchase date.
- Color availability on replacement and aftermarket JetPaks is guaranteed for a minimum of one year. (Color availability beyond one year is dependent upon market demand and availability of color to Bullfrog.)

### **Ozone System**

- Bullfrog warrants the ozone system against defects in materials and workmanship for one year from the original spa purchase date.

## **Other Warranties**

- Bullfrog warrants the Bullfrog Spa pillows, stainless steel jet faces, ventilation screen, and filter cartridge(s) against defects in materials and workmanship through time of delivery.
- Spa covers and all other spa accessories attached to the Bullfrog Portable Spa after date of manufacture are not covered by this limited warranty. Please refer to the manufacturer of such products for information regarding warranty coverage.

## **1 Year Warranty**

### **Lighting System**

- Bullfrog warrants the Interior and Exterior Spa Lighting System against defects in materials and workmanship for one year from the original spa purchase date. Defective components that are easily removed from the spa, such as the exterior LED bulb (including sconce), which are deemed Easily Removed Components, will be repaired or replaced free of charge at your authorized Bullfrog Spa Dealer or by sending the defective component(s) to Bullfrog.
- Stereo System
- Bullfrog warrants the Bullfrog Elite Audio and Life Audio stereo systems against defects in materials and workmanship for one year from the original spa purchase date.

## **R SERIES WARRANTY**

Bullfrog International, LC (“Bullfrog”) extends warranty coverage solely to the end-user purchaser (“Owner”) of any 2016 model R Series portable Bullfrog Spa installed for residential use in the United States or Canada.

## **Lifetime Warranty**

### **EnduraFrame™**

Bullfrog warrants the EnduraFrame (injectionmolded spa frame) against degradation for the life of the original retail purchaser of the spa.

## **7 Year Warranty**

### **Shell Structure**

Bullfrog warrants the Bullfrog Spa shell not to leak for seven years from the original spa purchase date.

## **5 Year Warranty**

### **Shell Surface**

Bullfrog warrants the surface finish of the Bullfrog Spa not to crack, wrinkle, blister, peel or delaminate for five years from the original spa purchase date.

## **5 Year Warranty**

### **Equipment**

- Warranty specifically covers the pump(s), heater, control system (including fuses), Snap Caps™, FilterCap™, other Bullfrog mechanical equipment, and leaks from any component or plumbing fitting located beneath the spa shell.
- Electrical and mechanical equipment with its associated piping and fittings warranted against defects in materials and workmanship for five years from purchase date.
- Defective components that are easily removed from the spa and that can be readily replaced by the customer and do not require specialized tools or knowledge or create personal safety issues, all of which are deemed Easily Removed Components, will be repaired or replaced free of charge at your authorized Bullfrog Spa Dealer or by sending the defective component(s) to Bullfrog. This warranty excludes audio systems, the ozone system, and the interior and exterior spa lighting systems.
- EternaWood Cabinet

- Warranty specifically covers the cabinet corners, door and side panels, and the molded spa base.
- EternaWood Cabinet sections (corners, doors, side panels) & EnduraBase™ are warranted against degradation and cracking for five years from purchase date. Defective items will be replaced under the terms of this warranty.
- JetPak Therapy System
- Warranty specifically covers the jets, any leaks from JetPak jet fittings, and all JetPak plumbing.
- JetPak plumbing System warranted for five years from purchase date.
- Color availability on replacement and aftermarket JetPaks is guaranteed for a minimum of
- one year. (Color availability beyond one year is dependent upon market demand and avail
- ability of color to Bullfrog.)

## 1 Year Warranty

### Lighting System

Bullfrog warrants the Interior and Exterior Spa Lighting System against defects in materials and workmanship for one year from the original spa purchase date. Defective components that are easily removed from the spa, such as the exterior LED bulb (including sconce), which are deemed Easily Removed Components, will be repaired or replaced free of charge at your authorized Bullfrog Spa Dealer or by sending the defective component(s) to Bullfrog.

### Stereo System

Bullfrog warrants the Bullfrog Elite Audio and Life Audio stereo systems against defects in materials and workmanship for one year from the original spa purchase date.

### Ozone System

Bullfrog warrants the ozone system against defects in materials and workmanship for one year from the original spa purchase date.

## Other Warranties

- Bullfrog warrants the Bullfrog Spa pillows, stainless steel jet faces, ventilation screen, and filter cartridge(s) against defects in materials and workmanship through time of delivery.
- Spa covers and all other spa accessories attached to the Bullfrog Portable Spa after date of manufacture are not covered by this limited warranty. Please refer to the manufacturer of such products for information regarding warranty coverage.

## X-SERIES SERIES WARRANTY

Bullfrog International, LC (“Bullfrog”) extends warranty coverage solely to the end-user purchaser (“Owner”) of any portable Bullfrog Spa manufactured on or after February 18, 2013 for 2013 and later models installed for residential use in the United States or Canada.

## 5 Year Warranty

### EnduraFrame™

Bullfrog warrants the EnduraFrame (injectionmolded spa frame) against degradation for five years from the original spa purchase date.

## 5 Year Warranty

### Shell Structure

Bullfrog warrants the Bullfrog Spa shell not to leak for five years from the original spa purchase date.

## 3 Year Warranty

### Shell Surface

Bullfrog warrants the surface finish of the Bullfrog Spa not to crack, wrinkle, blister, peel or delaminate for three years from the original spa purchase date.

### Equipment

- Warranty specifically covers the pump(s), heater, control system (including fuses), Snap Caps™, FilterCap™, other Bullfrog mechanical equipment, and leaks from any component or plumbing fitting located beneath the spa shell.
- Electrical and mechanical equipment with its associated piping and fittings warranted against defects in materials and workmanship for five years from purchase date.
- Defective components that are easily removed from the spa and that can be readily re placed by the customer and do not require specialized tools or knowledge or create personal safety issues, all of which are deemed Easily Removed Components, will be repaired or replaced free of charge at your authorized Bullfrog Spa Dealer or by sending the defective component(s) to

Bullfrog. This warranty excludes audio systems, the ozone system, and the interior and exterior spa lighting systems.

### **EternaWood Cabinet**

Warranty specifically covers the cabinet corners, door and side panels, and the molded spa base.

- EternaWood Cabinet sections (corners, doors, side panels) & EnduraBase™ are warranted against degradation and cracking for five years from purchase date. Defective items will be replaced under the terms of this warranty.

### **JetPak Therapy System**

- Warranty specifically covers the jets, any leaks from JetPak jet fittings, and all JetPak plumbing.
- JetPak plumbing System warranted for five years from purchase date.
- Color availability on replacement and aftermarket JetPaks is guaranteed for a minimum of one year. (Color availability beyond one year is dependent upon market demand and availability of color to Bullfrog.)

## **1 Year Warranty**

### **Lighting System**

- Bullfrog warrants the Interior and Exterior Spa Lighting System against defects in materials and workmanship for one year from the original spa purchase date. Defective components that are easily removed from the spa, such as the exterior LED bulb (including sconce), which are deemed Easily Removed Components, will be repaired or replaced free of charge at your authorized Bullfrog Spa Dealer or by sending the defective component(s) to Bullfrog.

### **Ozone System**

- Bullfrog warrants the ozone system against defects in materials and workmanship for one year from the original spa purchase date.

### **Other Warranties**

- Bullfrog warrants the Bullfrog Spa pillows, stainless steel jet faces, ventilation screen, and filter cartridge(s) against defects in materials and workmanship through time of delivery.
- Spa covers and all other spa accessories attached to the Bullfrog Portable Spa after date of manufacture are not covered by this limited warranty. Please refer to the manufacturer of such products for information regarding warranty coverage.

## **Warranty Performance**

Bullfrog or its authorized agent will repair or replace any malfunction or defective component on the Bullfrog Spa that is covered under the terms of this limited warranty and was purchased from an authorized Bullfrog spa dealer.

In doing so, Bullfrog reserves the right, at its option, to either repair or replace the defective spa or component.

If Bullfrog Spas determines that the repair of the defect is not feasible, we reserve the right to instead provide a replacement spa equal in value to the original purchase price of the defective spa. In such an event costs for removal of the defective spa, shipping costs of the replacement spa and delivery will be the responsibility of the spa owner. After seven years from the original spa purchase date the defective spa must be sent to Bullfrog for repair in the event of a structure or frame failure. Bullfrog reserves the right to use either new or reconditioned replacement components. In some situations, the servicing dealer may charge you a reasonable travel mileage fee. Any repair or replacement shall provide no new warranty coverage, but shall retain only the remaining portion of the original product's warranty.

Bullfrog's Lifetime warranties provide coverage solely to the original retail purchaser of the spa and extend only for the length of his or her lifetime. If the original retail purchaser is not a natural person (i.e. Corporation, L.L.C., Family Trust, etc.), "life of the purchaser" shall mean ten years.

To obtain warranty service, contact your authorized Bullfrog Spa Dealer or Bullfrog and submit proof of purchase. Any defective spa or component sent directly to the factory for warranty repair must be pre-authorized by Bullfrog and must be freight prepaid. Return freight will be paid by Bullfrog on all warranted components and spas, excluding any spa returned that is more than seven years after its purchase date. If the entire spa is sent to the factory for repair, all costs of removing and re-installing the spa at spa owner's location will be the responsibility of the spa owner. Repair or replacement, as described above, shall be Bullfrog's sole liability for any breach of this limited warranty.

## Exclusions

This Bullfrog Spa limited warranty is void if any of the following occur:

- The spa has been subject to alteration, neglect, misuse or abuse.
- Any repairs are attempted by anyone other than an authorized agent of Bullfrog.
- The spa has been used in a non-residential application or in an application for which it was not designed.
- Damage is caused by an Act of God or any other cause beyond the control of Bullfrog.
- Damage is caused by the addition or use of any non-approved mechanical or electrical component, or chemical substance.
- Damage is caused by shipping, moving, mishandling, improper installation or electrical hook-up by someone other than Bullfrog.
- Damage to the spa shell is caused by excessive heat buildup due to failure to cover spa while empty of water and/or exposed to direct sunlight.
- Damage is caused by operating the spa outside the water temperature range of 32°F-120°F (0°C-49°C).
- Damage is caused by improper maintenance of spa water chemistry or by allowing undissolved spa chemicals to lie on the spa's surface.
- Damage is caused by failure to install, maintain and operate the spa in accordance with the recommendations contained in the Bullfrog Owner's Manual, Pre-Delivery Guide or any other printed instructions, notice or bulletin from Bullfrog.

## Limitations

THIS LIMITED WARRANTY TAKES THE PLACE OF ALL OTHER WARRANTIES, EXPRESS OR IMPLIED, IN FACT OR AT LAW, INCLUDING IMPLIED WARRANTIES OF MERCHANTABILITY AND FITNESS FOR A PARTICULAR PURPOSE. ALL WARRANTY SERVICE MUST BE PERFORMED BY BULLFROG OR ITS AUTHORIZED AGENT. NO AGENT, DEALER, DISTRIBUTOR, SERVICE COMPANY OR OTHER PARTY IS AUTHORIZED TO CHANGE, MODIFY OR EXTEND THE TERMS OF THIS LIMITED WARRANTY IN ANY MANNER WHATSOEVER.

REPLACE ANY AFTER MARKET ACCESSORY (COVER LIFTER, GAZEBO, ETC.), FINISH (TILE, STONE, ETC.) OR OTHER ITEM (ELECTRICAL CONNECTION, BENCH, DECKING, PLANTER BOX, ETC.) THAT IS EITHER ATTACHED OR ADJACENT TO THE SPA, WHETHER THE REPAIR IS BEING DONE AT THE OWNER'S LOCATION, DEALER'S FACILITY OR AT BULLFROG, WILL BE THE COMPLETE RESPONSIBILITY OF THE SPA OWNER. REPAIR OR REPLACEMENT AS DESCRIBED ABOVE SHALL BE BULLFROG'S SOLE LIABILITY FOR ANY BREACH OF

THIS LIMITED WARRANTY. SEE MORE AT <http://www.bullfrogspas.com/pre-2013warranty#sthash.KtfxFVN0.dpuf>

## Disclaimers

BULLFROG AND ITS AUTHORIZED AGENTS SHALL NOT BE LIABLE FOR ANY INJURY, LOSS, COST OR OTHER DAMAGE, WHETHER INCIDENTAL, CONSEQUENTIAL, SPECIAL OR PUNITIVE, ARISING OUT OF ANY DEFECT COVERED BY THIS LIMITED WARRANTY, INCLUDING WITHOUT LIMITATION, LOSS OF USE OF THE SPA AND COST FOR REMOVAL OF DEFECTIVE PRODUCT, EVEN IF BULLFROG HAS BEEN ADVISED OF THE POSSIBILITY OF SUCH DAMAGE. THE LIABILITY OF BULLFROG UNDER THIS LIMITED WARRANTY, IF ANY, SHALL NOT EXCEED THE ORIGINAL AMOUNT PAID FOR THE DEFECTIVE PRODUCT. COVERAGE UNDER THIS LIMITED WARRANTY SHALL COMMENCE AS OF THE ORIGINAL DATE OF PURCHASE AND THE DURATION OF SUCH COVERAGE SHALL NOT EXTEND FOR ANY REASON WHATSOEVER BEYOND THE STATED TIME PERIOD. THESE DISCLAIMERS SHALL BE EQUALLY APPLICABLE TO ANY SERVICE PROVIDED BY BULLFROG OR ITS AUTHORIZED AGENTS. IN ORDER TO PROVIDE WARRANTY SERVICE TO THE SPA, THE COST TO REMOVE AND



# Legal Rights

This Limited Warranty gives you specific legal rights. You may also have other rights which vary from state to state. Some states do not allow limitations on how long an implied warranty lasts, so this limitation may not apply to you. Prompt return of a completed warranty registration form protects your warranty rights.

**U.S. Patents:** 7,908,684, 8,661,576, 8,881,321, 8,689,370, 8,869,469, 5,754,989, 5,987,663, 6,000,073, 6,092,246, 6,256,805, 6,543,067.

**New Zealand Patent:** 555112, 334,093

**Australia Patent:** 737,335

**Canada Patents:** 2,588,884, 2,260,237,

**Other patents pending worldwide**

14600 South 668 West • Bluffdale, Utah 84065 .

Tel (801) 565-8111 • Fax (801) 565-8333

[www.bullfrogspas.com](http://www.bullfrogspas.com) • [info@bullfrogspas.com](mailto:info@bullfrogspas.com)



Bullfrog International, LC  
668 W. 14600 S.  
Bluffdale, UT 84065  
T: 801.565.8111  
F: 801.565.8333  
E: [info@bullfrogspas.com](mailto:info@bullfrogspas.com)

v 1.01

Register your spa online by visiting:  
[bullfrogspas.com/register](http://bullfrogspas.com/register)

North America 2016  
Bullfrog International, LC



---

# BULLFROG SPAS OWNERS MANUAL

---

**bullfrog**<sup>®</sup>  
spas